

**TITLE: MV215FHM-N72**  
**Final Product Specification**  
**Ver.O**

**BEIJING BOE DISPLAY TECHNOLOGY**

**SPEC. NUMBER**  
S8-65-8A-125

**PRODUCT GROUP**  
TFT-LCD

Ver.O

**ISSUE DATE**  
2021.03.09

**PAGE**  
1 OF 29



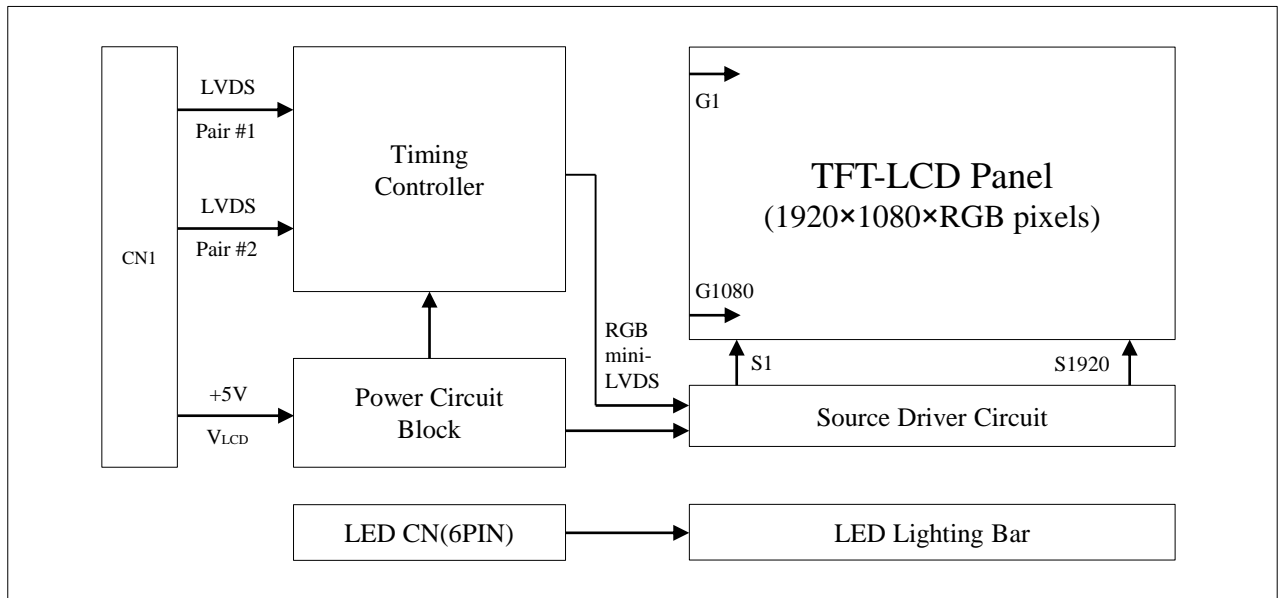
## Contents

No	ITEM	Page
	REVISIONS HISTORY	2
	CONTENTS	3
1	GENERAL DESCRIPTION	4
	1.1 Introduction	4
	1.2 Features	4
	1.3 Application	5
	1.4 General Specifications	5
2	ABSOLUTE MAXIMUM RATINGS	6
3	ELECTRICAL SPECIFICATIONS	7
	3.1 Electrical Specifications	7
	3.2 Backlight Unit	8
4	OPTICAL SPECIFICATIONS	9
5	INTERFACE CONNECTION	11
	5.1 Electrical Interface Connection	11
	5.2 LVDS Interface	13
6	SIGNAL TIMING SPECIFICATIONS	14
7	SIGNAL TIMING WAVEFORMS OF INTERFACE SIGNAL	16
8	INPUT SIGNALS, BASIC DISPLAY COLORS & GRAY SCALE OF COLORS	18
9	POWER SEQUENCE	19
10	MECHANICAL CHARACTERISTICS	20
11	RELIABILITY TEST	21
12	HANDING & CAUTIONS	22
13	PRODUCT SERIAL NUMBER	23
14	PACKING INFORMATION	24
15	APPENDIX (with Mechanical Outline Dimension)	26

## 1.0 GENERAL DESCRIPTION

### 1.1 Introduction

MV215FHM-N72 is a color active matrix TFT LCD module using amorphous silicon TFT's (Thin Film Transistors) as an active switching devices. This module has a 21.5 inch diagonally measured active area with FHD resolutions (1920 horizontal by 1080 vertical pixel array). Each pixel is divided into RED, GREEN, BLUE dots which are arranged in vertical stripe and this module can display 16.7M colors. The TFT-LCD panel used for this module is adapted for a low reflection and higher color type.



### 1.2 Features

- LVDS Interface with 2 pixel / clock
- High-speed response
- 6-bit (Hi-FRC) color depth, display 16. 7M colors
- High luminance and contrast ratio, low reflection and wide viewing angle
- DE (Data Enable) only
- RoHS/Halogen Free
- TCO 8.0, ES 8.0 compliant,
- TUV low blue light panel
- Gamma Correction
- Reverse type
- Low blue light panel

### 1.3 Application

- Desktop Type of PC & Workstation Use
- Slim-Size Display for Stand-alone Monitor
- Display Terminals for Control System
- Monitors for Process Controller

### 1.4 General Specifications

The followings are general specifications at the model MV215FHM-N72.

< Table 1. General Specifications >

Parameter	Specification	Unit	Remarks
Active area	476.064(H) × 267.786(V)	mm	
Number of pixels	1920(H) × 1080(V)	pixels	
Pixel pitch	0.24795(H) × 0.24795(V)	mm	
Pixel arrangement	RGB Vertical stripe		
Display colors	16.7M	colors	
Display mode	Normally Black		
Dimensional outline	484.464(H) x 284.486(V) x 11(D) typ.	mm	Detail refer to drawing
Weight	1800(Typ.)	g	
Surface Treatment	Haze 25%, 3H		
Back-light	Down edge side 1-LED light bar type		
Low Blue Light panel	The ratio of light in the range from 415nm~455nm compared to 400nm~500nm shall be less than 50%		

### 2.0 ABSOLUTE MAXIMUM RATINGS

The followings are maximum values which, if exceed, may cause faulty operation or damage to the unit. The operational and non-operational maximum voltage and current values are listed in Table 2.

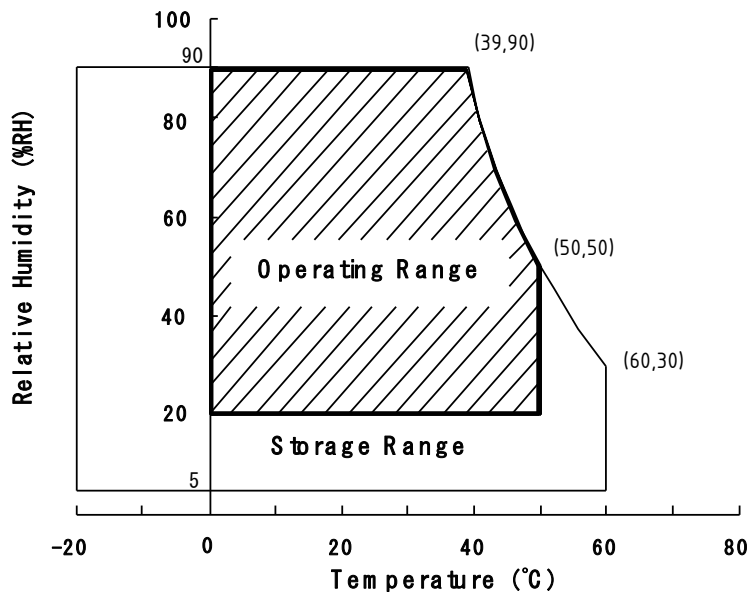
< Table 2. Absolute Maximum Ratings >

[VSS=GND=0V]

Parameter	Symbol	Min.	Max.	Unit	Remarks
Power Supply Voltage	$V_{DD}$	-0.3	5.5	V	Ta = 25 °C
Logic Supply Voltage	$V_{IN}$	VSS-0.3	$V_{DD}+0.3$	V	
Operating Temperature	$T_{OP}$	0	+50	°C	Note 1
Storage Temperature	$T_{ST}$	-20	+60	°C	Note 1
LCM Surface Temperature (Operation)	Tsurface	0	+65	°C	Note 2

Note :

1. Temperature and relative humidity range are shown in the figure below. Wet bulb temperature should be 39°C max. and no condensation of water.
2. Panel Surface Temperature should be Min. 0°C and Max. +65°C under the VDD = 5.0V, Frame rate = 60Hz, 25°C ambient Temp. no humidity control and LED string current is typical value.



## 3.0 ELECTRICAL SPECIFICATIONS

### 3.1 Electrical Specifications

< Table 3. Electrical Specifications >

[Ta =25±2 °C]

Parameter		Min.	Typ.	Max.	Unit	Remarks
Power Supply Voltage	V <sub>DD</sub>	4.5	5.0	5.5	V	
Power Supply Current	I <sub>DD</sub> Typ.	-	380	440	mA	Note1
	I <sub>DD</sub> Max.		700	800	mA	
In-Rush Current	I <sub>RUSH</sub>	-	2.0	3	A	Note 2
Permissible Input Ripple Voltage	V <sub>RF</sub>	-	-	300	mV	V <sub>DD</sub> = 5.0V
High Level Differential Input Threshold Voltage	V <sub>IH</sub>	-	-	+100	mV	
Low Level Differential Input Threshold Voltage	V <sub>IL</sub>	-100	-	-	mV	
Differential input voltage	V <sub>ID</sub>	200	-	600	mV	
Differential input common mode voltage	V <sub>cm</sub>	1.0	1.2	1.5	V	V <sub>IH</sub> =100mV, V <sub>IL</sub> =-100mV
Power Consumption	P <sub>D</sub> Typ.	-	1.9	2.2	W	Note1
	P <sub>D</sub> Max.		3.5	4	W	
	P <sub>BL</sub>	-	8.57	8.87	W	100% duty, Note 3
	P <sub>total</sub> Typ.	-	10.47	10.77	W	Note1
	P <sub>total</sub> Max.		12.07	12.87	W	
	P <sub>Energy star</sub>	-	-	8.7	W	Note 4

Notes : 1. The supply voltage is measured and specified at the interface connector of LCM.

The current draw and power consumption specified is for VDD=5.0V. Test Pattern of power supply current

a) Typ : Color Bar pattern, Frame rate=60Hz

b) Max : Vertical Subline pattern, Frame rate=75Hz



a) Typ : Color Bar



b) Max : Vertical SubLine 255

2. Duration of rush current is about 2 ms and rising time of VDD is 520 μs ± 20 %

3. Calculated value for reference (VL × IL) ×4(channel) excluding driver loss. (LED Light bar: 17S4P)

4. Test measure refer to ENERGY STAR 8.0 Program Requirements@200nit

SPEC. NUMBER

S8-65-8A-125

SPEC. TITLE

B4 MV215FHM-N72 Final Product Specification Ver.O

PAGE

7 OF 29

### 3.2 Backlight Unit

< Table 4. LED Backlight Unit >

Parameter		Min.	Typ.	Max.	Unit	Remarks
LED Light Bar Input Voltage Per Input Pin	VPIN	-	47.6	49.3	V	Duty 100%
LED Light Bar Input Current Per Input Pin	IPIN	-	45	-	mA	Note 1,2
LED Power Consumption	P <sub>BL</sub>	-	8.57	8.87	W	Note 3
LED Life-Time	-	30,000	-		Hrs	Note 4

#### LED bar consists of 68LED packages, 4strings(parallel)\*17packages(serial)

Note : 1. There are one light bar ,and the specified current is input LED chip 100% duty current.

2. The sense current of each input pin is 45mA.

3.  $P_{BL} = 4 \text{ Input pins} \times V_{PIN} \times I_{PIN}$ .

4. The lifetime is determined as the time at which luminance of LED become 50% of the initial brightness or not normal lighting at  $I_{PIN} = 45\text{mA}$  on condition of continuous operating at  $25 \pm 2 \text{ }^\circ\text{C}$



## 4.0 OPTICAL SPECIFICATION

### 4.1 Overview

The test of Optical specifications shall be measured in a dark room (ambient luminance  $\leq 1$  lux and temperature =  $25 \pm 2^\circ\text{C}$ ) with the equipment of Luminance meter system (Goniometer system and TOPCONE PR730) and test unit shall be located at an approximate distance 50cm from the LCD surface at a viewing angle of  $\theta$  and  $\Phi$  equal to  $0^\circ$ . We refer to  $\theta_{\Phi=0}$  ( $=\theta_3$ ) as the 3 o'clock direction (the "right"),  $\theta_{\Phi=90}$  ( $=\theta_{12}$ ) as the 12 o'clock direction ("upward"),  $\theta_{\Phi=180}$  ( $=\theta_9$ ) as the 9 o'clock direction ("left") and  $\theta_{\Phi=270}$  ( $=\theta_6$ ) as the 6 o'clock direction ("bottom"). While scanning  $\theta$  and/or  $\Phi$ , the center of the measuring spot on the Display surface shall stay fixed. The measurement shall be executed after 30 minutes warm-up period. VDD shall be 5.0V +/-10% at  $25^\circ\text{C}$ . Optimum viewing angle direction is 6 'clock.

### 4.2 Optical Specifications

< Table 5. Optical Specifications >

[VDD = 5.0V, Frame rate = 60Hz, Clock = 74MHz,  $I_{BL} = 180\text{mA}$ ,  $T_a = 25 \pm 2^\circ\text{C}$ ]

Parameter		Symbol	Condition	Min.	Typ.	Max.	Unit	Remark
Viewing Angle range	Horizontal	$\Theta_3$	CR > 10	85	89	-	Deg.	Note 1
		$\Theta_9$		85	89	-	Deg.	
	Vertical	$\Theta_{12}$		85	89	-	Deg.	
		$\Theta_6$		85	89	-	Deg.	
Luminance Contrast ratio		CR		700	1000			Note 2
Luminance of White		$Y_w$		200	250		cd/m <sup>2</sup>	Note 3
White luminance uniformity		$\Delta Y$		75	-		%	Note 4
Reproduction of color	White	$W_x$	$\Theta = 0^\circ$ (Center) Normal Viewing Angle	0.283	0.313	0.343	-	Note 5
		$W_y$		0.299	0.329	0.359	-	
	Red	$R_x$		0.632	0.662	0.692	-	
		$R_y$		0.304	0.334	0.364	-	
	Green	$G_x$		0.277	0.307	0.337	-	
		$G_y$		0.592	0.622	0.652	-	
	Blue	$B_x$		0.114	0.144	0.174	-	
		$B_y$		0.017	0.047	0.077	-	
Color Gamut				95	99	-	%	sRGB CIE 1931
Response Time	GTG	$T_g$			14	25	ms	Note 6

**Note:**

- Viewing angle is the angle at which the contrast ratio is greater than 10. The viewing are determined for the horizontal or 3, 9 o'clock direction and the vertical or 6, 12 o'clock direction with respect to the optical axis which is normal to the LCD surface.
- Contrast measurements shall be made at viewing angle of  $\theta = 0^\circ$  and at the center of the LCD surface. Luminance shall be measured with all pixels in the view field set first to white, then to the dark (black) state. (See FIGURE 1 shown in Appendix) Luminance Contrast Ratio (CR) is defined mathematically.

$$CR = \frac{\text{Luminance when displaying a white raster}}{\text{Luminance when displaying a black raster}}$$

- Center Luminance of white is defined as the LCD surface. Luminance shall be measured with all pixels in the view field set first to white. This measurement shall be taken at the locations shown in FIGURE 2 in Appendix for a total of the measurements per display.
- The White luminance uniformity on LCD surface is then expressed as:  
 $\Delta Y = ( \text{Minimum Luminance of 9points} / \text{Maximum Luminance of 9points} ) * 100$   
 (See FIGURE 2 shown in Appendix).
- The color chromaticity coordinates specified in Table 5. shall be calculated from the spectral data measured with all pixels first in red, green, blue and white. Measurements shall be made at the center of the panel.
- Response time Tg is the average time required for display transition by switching the input signal as below table and is based on Frame rate fV =60Hz to optimize. Each time in below table is defined as FIGURE 3 in Appendix and shall be measured by switching the input signal for “any level of gray(bright)”and “any level of gray(dark)”.

Measured Response Time	Target																
	0	15	31	47	63	79	95	111	127	143	159	175	191	207	223	239	255
0																	
15																	
31																	
47																	
63																	
79																	
95																	
111																	
127																	
143																	
159																	
175																	
191																	
207																	
223																	
239																	
255																	

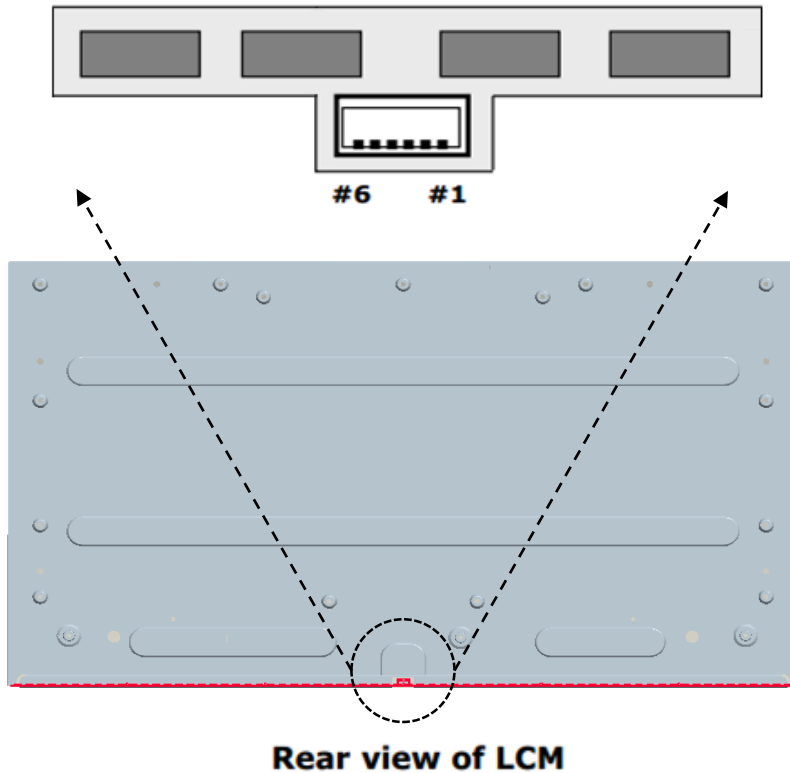
## 5.0 INTERFACE CONNECTION

### 5.1 Electrical Interface Connection

- LED connector: BM06B-SHJS-TB(JST) or 10035WS-H06B(YEONHO) or Equivalent

< Table 6. LED connector >

Pin No	Symbol	Description
1	IRLED1	LED current sense for string1
2	IRLED2	LED current sense for string2
3	VLED	LED power supply
4	VLED	LED power supply
5	IRLED3	LED current sense for string3
6	IRLED4	LED current sense for string4



Rear view of LCM

**- CN1:**

Module Side Connector : UJU IS100-L300-C23 or Equivalent

User Side Connector : JAE FI-X30H or Equivalent

< Table 7. CN1 connector >

Pin No	Symbol	Function	Remark
1	RX00-	Negative Transmission data of Pixel 0 (ODD)	
2	RX00+	Positive Transmission data of Pixel 0 (ODD)	
3	RX01-	Negative Transmission data of Pixel 1 (ODD)	
4	RX01+	Positive Transmission data of Pixel 1 (ODD)	
5	RX02-	Negative Transmission data of Pixel 2 (ODD)	
6	RX02+	Positive Transmission data of Pixel 2 (ODD)	
7	BIST	Power Ground	
8	RXOC-	Negative Transmission Clock (ODD)	
9	RXOC+	Positive Transmission Clock (ODD)	
10	RX03-	Negative Transmission data of Pixel 3 (ODD)	
11	RX03+	Positive Transmission data of Pixel 3 (ODD)	
12	RXE0-	Negative Transmission data of Pixel 0 (EVEN)	
13	RXE0+	Positive Transmission data of Pixel 0 (EVEN)	
14	GND	Power Ground	
15	RXE1-	Negative Transmission data of Pixel 1 (EVEN)	
16	RXE1+	Positive Transmission data of Pixel 1 (EVEN)	
17	GND	Power Ground	
18	RXE2-	Negative Transmission data of Pixel 2 (EVEN)	
19	RXE2+	Positive Transmission data of Pixel 2 (EVEN)	
20	RXEC-	Negative Transmission Clock (EVEN)	
21	RXEC+	Positive Transmission Clock (EVEN)	
22	RXE3-	Negative Transmission data of Pixel 3 (EVEN)	
23	RXE3+	Positive Transmission data of Pixel 3 (EVEN)	
24	GND	Power Ground	
25	NC	*Reserved for LCD manufacturer's use (CTL_DVR)	
26	NC	*Reserved for LCD manufacturer's use (CE_DVR)	
27	NC	No Connection	
28	VDD	Power Supply: +5V	
29	VDD		
30	VDD		

## 5.2 LVDS Interface (Tx; THC63LVDF83A or Equivalent)

< Table 8. LVDS Interface >

	Input Signal	Transmitter		Interface		MV215FHM-N72 (CN11)	Remark
		Pin No.	Pin No.	System (Tx)	TFT-LCD (Rx)	Pin No.	
L V D S	OR0	51	48 47	OUT0- OUT0+	RXO0- RXO0+	1 2	
	OR1	52					
	OR2	54					
	OR3	55					
	OR4	56					
	OR5	3					
	OG0	4	46 45	OUT1- OUT1+	RXO1- RXO1+	3 4	
	OG1	6					
	OG2	7					
	OG3	11					
	OG4	12					
	OG5	14					
	OB0	15	42 41	OUT2- OUT2+	RXO2- RXO2+	5 6	
	OB1	19					
	OB2	20					
	OB3	22					
	OB4	23					
	OB5	24					
	Hsync	27	40 39	CLK OUT- CLK OUT+	RXO CLK- RXO CLK+	8 9	
	Vsync	28					
	DE	30	38 37	OUT3- OUT3+	RXO3- RXO3+	10 11	
	MCLK	31					
	OR6	50					
	OR7	2					
	OG6	8					
OG7	10						
OB6	16						
OB7	18						
RSVD	25						

Note : The order of even data is same with odd data.

## 6.0 SIGNAL TIMING SPECIFICATION

### 6.1 Timing Table

The MV215FHM-N72 is operated by the DE only.

< Table 9. Timing Table >

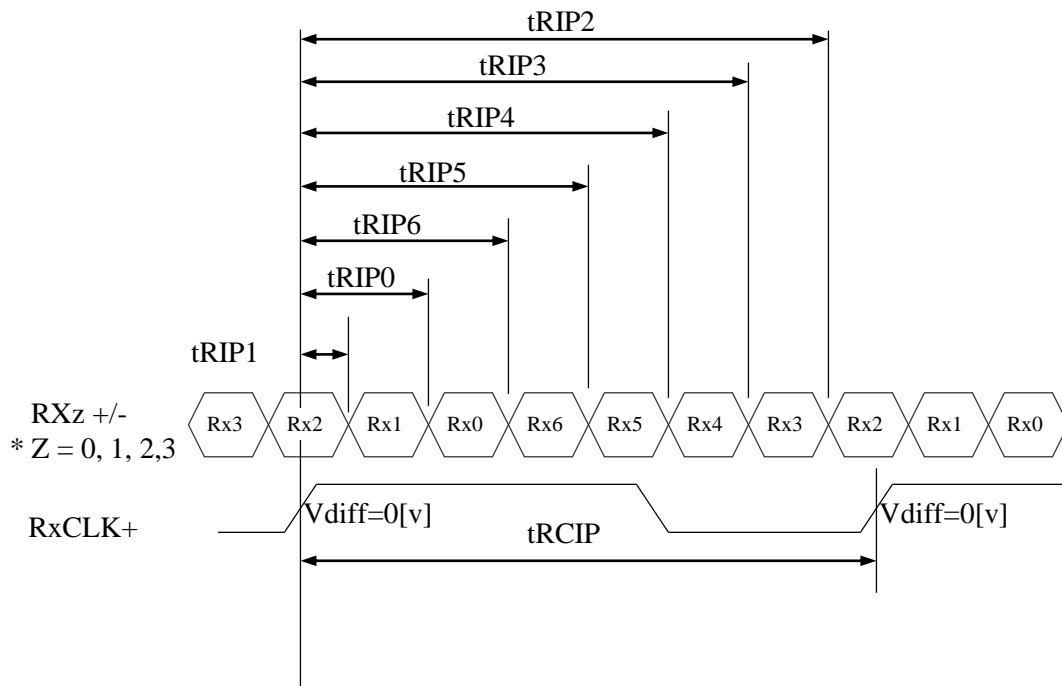
Item	Symbols		Min	Typ	Max	Unit	Note
DCLK	Period	tCLK	10.8	13.47	16.7	ns	
	Frequency	-	57.54	74	94	MHz	
Hsync	Period	tHP	1050	1100	1120	tCLK	
	Horizontal Valid	tHV	960	960	960	tCLK	
	Horizontal Blank	tHB	90	140	160		
	Frequency	fH	54	67	90	KHz	
Vsync	Period	tVP	1108	1125	1251	tHP	
	Vertical Valid	tVV	1080	1080	1080	tHP	
	Vertical Blank	tVB	28	45	171	tHP	
	Frequency	fV	48	60	77	Hz	
LVDS Receiver clock	Input spread spectrum ratio	SSr	-3	-	+3	%	

### 6.2 LVDS Rx Interface Timing Parameter

The specification of the LVDS Rx interface timing parameter is shown in Table 10.

< Table 10. LVDS Rx Interface Timing Specification >

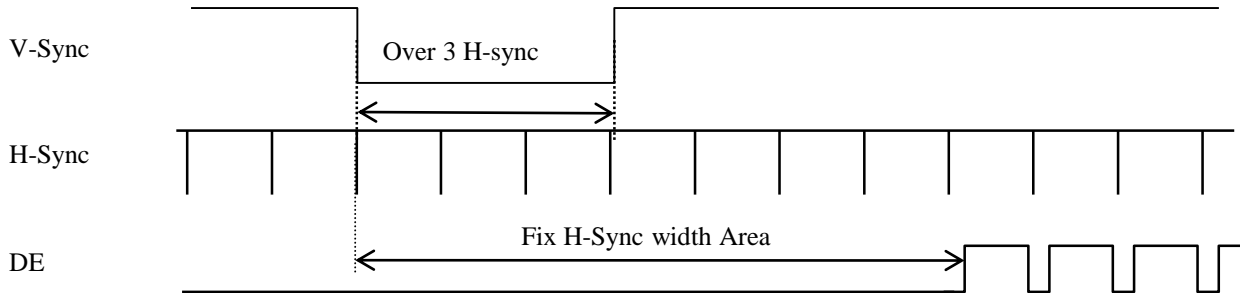
Item	Symbol	Min	Typ	Max	Unit	Remark
CLKIN Period	tRCIP	10.8	13.47	16.7	nsec	
Input Data 0	tRIP1	-0.4	0.0	+0.4	nsec	
Input Data 1	tRIP0	tRCIP/7-0.4	tRCIP/7	tRCIP/7+0.4	nsec	
Input Data 2	tRIP6	2 × tRCIP/7-0.4	2 × tRCIP/7	2 × tRCIP/7+0.4	nsec	
Input Data 3	tRIP5	3 × tRCIP/7-0.4	3 × tRCIP/7	3 × tRCIP/7+0.4	nsec	
Input Data 4	tRIP4	4 × tRCIP/7-0.4	4 × tRCIP/7	4 × tRCIP/7+0.4	nsec	
Input Data 5	tRIP3	5 × tRCIP/7-0.4	5 × tRCIP/7	5 × tRCIP/7+0.4	nsec	
Input Data 6	tRIP2	6 × tRCIP/7-0.4	6 × tRCIP/7	6 × tRCIP/7+0.4	nsec	



\*  $V_{diff} = (RXz+) - (RXz-), \dots, (RXCLK+) - (RXCLK-)$

## 7.0 SIGNAL TIMING WAVEFORMS OF INTERFACE SIGNAL

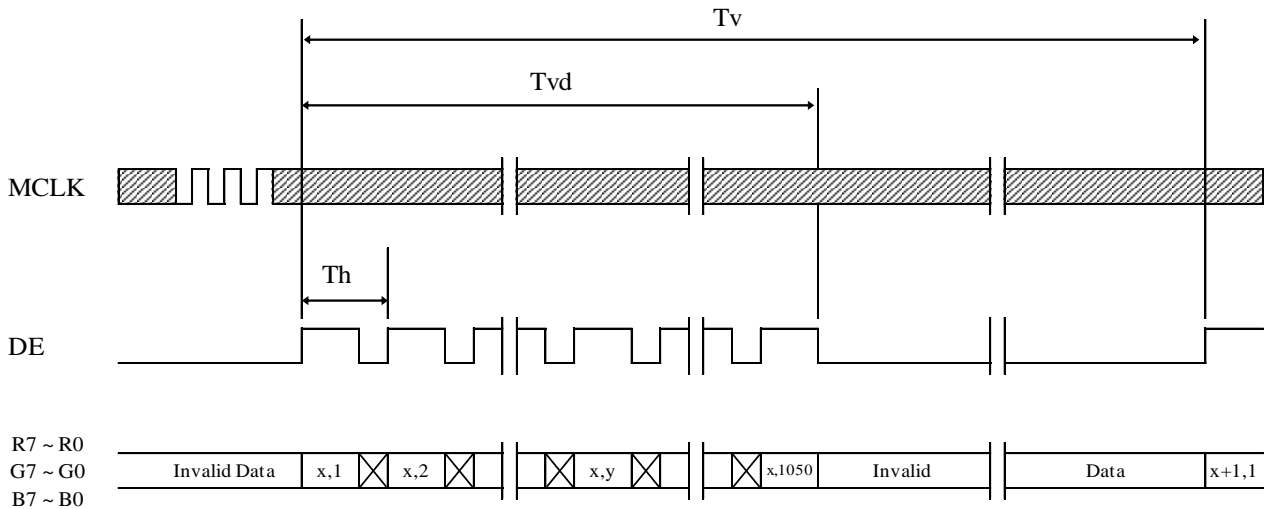
### 7.1 Sync Timing Waveforms



Note : 1. Need over 3 H-sync during V-Sync Low.

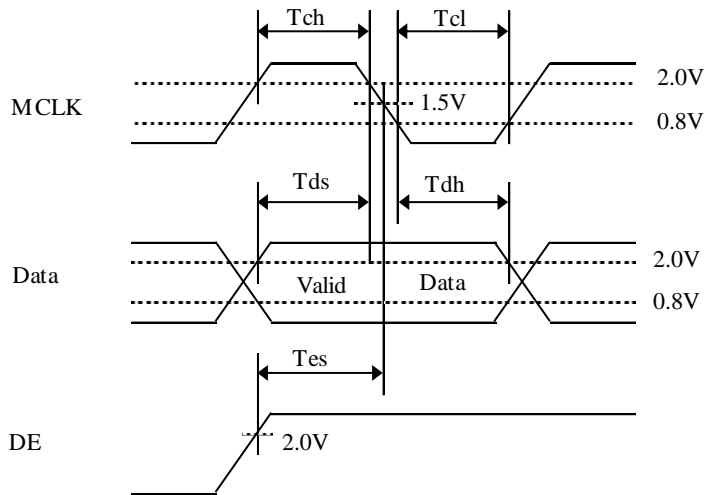
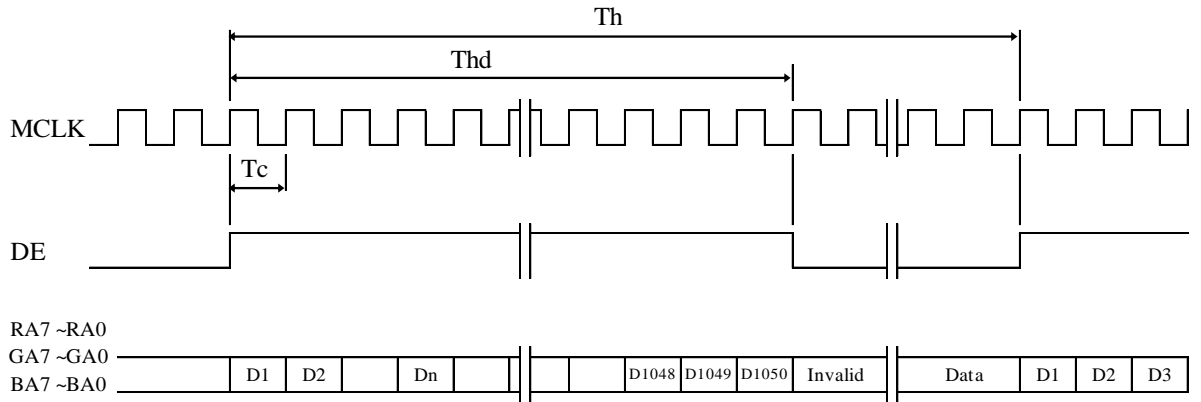
2. Fix H-Sync width from V-Sync falling edge to first rising edge.

### 7.2 Vertical Timing Waveforms





### 7.3 Horizontal Timing Waveforms



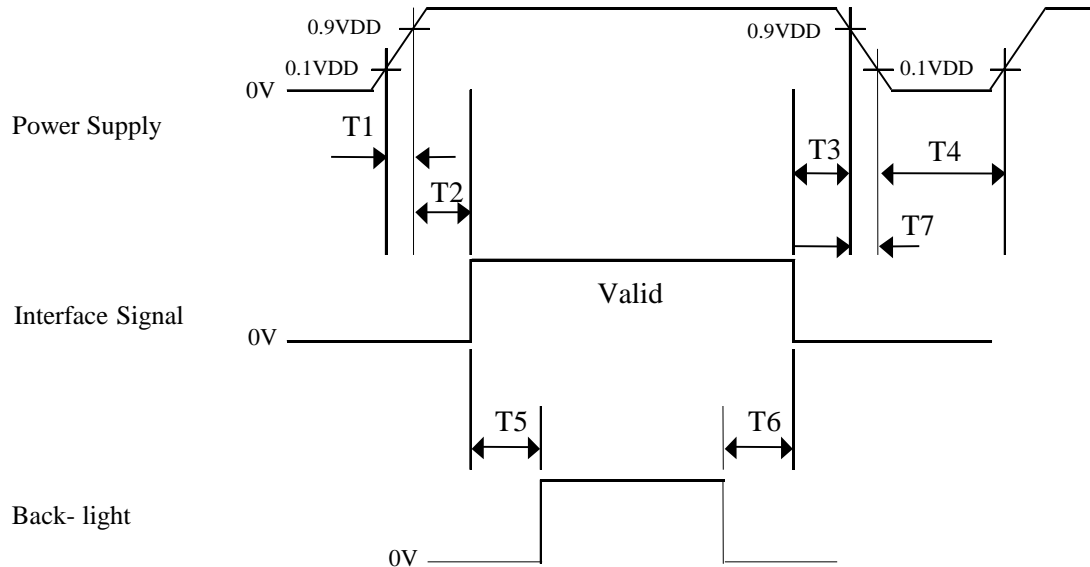
## 8.0 INPUT SIGNALS, BASIC DISPLAY COLORS & GRAY SCALE OF COLORS

< Table 11. Input Signals >

Color & Gray Scale		RED DATA								GREEN DATA								BLUE DATA							
		R7	R6	R5	R4	R3	R2	R1	R0	G7	G6	G5	G4	G3	G2	G1	G0	B7	B6	B5	B4	B3	B2	B1	B0
Basic Colors	Black	0	0	0	0	0	0	0	0	0	0	0	0	0	0	0	0	0	0	0	0	0	0	0	0
	Blue	0	0	0	0	0	0	0	0	0	0	0	0	0	0	0	0	1	1	1	1	1	1	1	1
	Green	0	0	0	0	0	0	0	0	1	1	1	1	1	1	1	1	0	0	0	0	0	0	0	0
	Cyan	0	0	0	0	0	0	0	0	1	1	1	1	1	1	1	1	1	1	1	1	1	1	1	1
	Red	1	1	1	1	1	1	1	1	0	0	0	0	0	0	0	0	0	0	0	0	0	0	0	0
	Magenta	1	1	1	1	1	1	1	1	0	0	0	0	0	0	0	0	1	1	1	1	1	1	1	1
	Yellow	1	1	1	1	1	1	1	1	1	1	1	1	1	1	1	1	0	0	0	0	0	0	0	0
	White	1	1	1	1	1	1	1	1	1	1	1	1	1	1	1	1	1	1	1	1	1	1	1	1
Gray Scale of RED	Black	0	0	0	0	0	0	0	0	0	0	0	0	0	0	0	0	0	0	0	0	0	0	0	0
	Δ	0	0	0	0	0	0	0	1	0	0	0	0	0	0	0	0	0	0	0	0	0	0	0	0
	Darker	0	0	0	0	0	0	1	0	0	0	0	0	0	0	0	0	0	0	0	0	0	0	0	0
	Δ	↑								↑								↑							
	▽	↓								↓								↓							
	Brighter	1	1	1	1	1	1	0	1	0	0	0	0	0	0	0	0	0	0	0	0	0	0	0	0
	▽	1	1	1	1	1	1	1	0	0	0	0	0	0	0	0	0	0	0	0	0	0	0	0	0
	Red	1	1	1	1	1	1	1	1	0	0	0	0	0	0	0	0	0	0	0	0	0	0	0	0
Gray Scale of GREEN	Black	0	0	0	0	0	0	0	0	0	0	0	0	0	0	0	0	0	0	0	0	0	0	0	0
	Δ	0	0	0	0	0	0	0	0	0	0	0	0	0	0	0	1	0	0	0	0	0	0	0	0
	Darker	0	0	0	0	0	0	0	0	0	0	0	0	0	0	1	0	0	0	0	0	0	0	0	0
	Δ	↑								↑								↑							
	▽	↓								↓								↓							
	Brighter	0	0	0	0	0	0	0	0	1	1	1	1	1	1	0	1	0	0	0	0	0	0	0	0
	▽	0	0	0	0	0	0	0	0	1	1	1	1	1	1	1	0	0	0	0	0	0	0	0	0
	Green	0	0	0	0	0	0	0	0	1	1	1	1	1	1	1	1	0	0	0	0	0	0	0	0
Gray Scale of BLUE	Black	0	0	0	0	0	0	0	0	0	0	0	0	0	0	0	0	0	0	0	0	0	0	0	0
	Δ	0	0	0	0	0	0	0	0	0	0	0	0	0	0	0	0	0	0	0	0	0	0	0	1
	Darker	0	0	0	0	0	0	0	0	0	0	0	0	0	0	0	0	0	0	0	0	0	0	0	1
	Δ	↑								↑								↑							
	▽	↓								↓								↓							
	Brighter	0	0	0	0	0	0	0	0	0	0	0	0	0	0	0	0	1	1	1	1	1	1	0	1
	▽	0	0	0	0	0	0	0	0	0	0	0	0	0	0	0	0	1	1	1	1	1	1	1	0
	Blue	0	0	0	0	0	0	0	0	0	0	0	0	0	0	0	0	1	1	1	1	1	1	1	1
Gray Scale of WHITE	Black	0	0	0	0	0	0	0	0	0	0	0	0	0	0	0	0	0	0	0	0	0	0	0	0
	Δ	0	0	0	0	0	0	0	1	0	0	0	0	0	0	0	1	0	0	0	0	0	0	0	1
	Darker	0	0	0	0	0	0	1	0	0	0	0	0	0	0	1	0	0	0	0	0	0	0	0	1
	Δ	↑								↑								↑							
	▽	↓								↓								↓							
	Brighter	1	1	1	1	1	1	0	1	1	1	1	1	1	1	0	1	1	1	1	1	1	1	0	1
	▽	1	1	1	1	1	1	1	0	1	1	1	1	1	1	1	0	1	1	1	1	1	1	1	0
	White	1	1	1	1	1	1	1	1	1	1	1	1	1	1	1	1	1	1	1	1	1	1	1	1

## 9.0 POWER SEQUENCE

To prevent a latch-up or DC operation of the LCD module, the power on/off sequence shall be as shown in below.



- $0.5 \text{ ms} \leq T1 \leq 10 \text{ ms}$
- $0 \leq T2 \leq 50 \text{ ms}$
- $0 < T3 \leq 50 \text{ ms}$
- $1 \text{ sec} \leq T4$
- $200 \text{ ms} \leq T5$
- $200 \text{ ms} \leq T6$

Note :

1. When the power supply VDD is 0V, keep the level of input signals on the low or keep high impedance.
2. Do not keep the interface signal high impedance when power is on.
3. Back Light must be turn on after power for logic and interface signal are valid.
4. T7 decreases smoothly, there is none re-bouncing voltage.
5. The above power sequence should be satisfied at these case
  - . DC power On/Off
  - . Mode Change (Resolution, frequency, timing, sleep mode, color depth change etc.)
 If not to follow above power sequence, there is a risk of abnormal display.
6. If  $T3=0\text{ms}$ , there is a risk of flicker when power On/Off.
7. If  $T6=0\text{ms}$ , there is a risk of abnormal display when power off. but it will be no reliability concern.

## 10.0 MECHANICAL CHARACTERISTICS

### 10.1 Dimensional Requirements

FIGURE 6 (located in Appendix) shows mechanical outlines for the model MV215FHM-N72. Other parameters are shown in Table 12.

< Table 12. Dimensional Parameters >

Parameter	Specification	Unit
Dimensional outline	484.464(H) x 284.486(V) x 11(D) typ.	mm
Weight	1800(Typ.)	gram
Active area	476.064(H) × 267.786(V)	mm
Pixel pitch	0.27495(H)mm x 0.27495(V)mm	mm
Number of pixels	1920 (H)×1080 (V) (1 pixel = R + G + B dots)	pixels
Back-light	Down edge side 1-LED light bar type	

### 10.2 Mounting

See FIGURE 5 (shown in Appendix).

### 10.3 Anti-Glare and Polarizer Hardness

The surface of the LCD has an anti-glare coating to minimize reflection and a coating to reduce scratching

### 10.4 Light Leakage

There shall not be visible light from the back-lighting system around the edges of the screen as seen from a distance 50cm from the screen with an overhead light level of 350lux.

### 10.5 Tilt/Pivot usage

Guarantee 30Khrs on static office circumstance ( $20\pm 5^{\circ}\text{C}$  & 35~75%RH) only for the panel peel off at tilt ( $-35^{\circ} \sim + 80^{\circ}$ ) and pivot ( $-180^{\circ} \sim + 180^{\circ}$ ) usage.

### 11.0 RELIABILITY TEST

The Reliability test items and its conditions are shown in below.

< Table 13. Reliability Test Parameters >

No	Test Items	Conditions	
1	High temperature storage test	Ta = 60 °C, 240 hrs	
2	Low temperature storage test	Ta = -20 °C, 240 hrs	
3	High temperature & high humidity operation test	Ta = 50 °C, 80%RH, 240hrs	
4	High temperature operation test	Ta = 50 °C, 240hrs	
5	Low temperature operation test	Ta = 0°C, 240hrs	
6	Thermal shock	Ta = -20 °C ↔ 60 °C (0.5 hr), 100 cycle	
7	Vibration test (non-operating)	Frequency	Random, 10 ~ 300 Hz, 30 min/Axis
		Gravity\ AMP	1.5 Grms
		Period	X, Y, Z 30 min
8	Shock test (non-operating)	Gravity	50G
		Pulse width	11msec, sine wave
		Direction	±X, ±Y, ±Z Once for each
9	Electro-static discharge test	Air : 150 pF, 330Ω, 15 KV Contact : 150 pF, 330Ω, 8 KV	

## 12.0 HANDLING & CAUTIONS

### (1) Cautions when taking out the module

- Pick the pouch only, when taking out module from a shipping package.

### (2) Cautions for handling the module

- As the electrostatic discharges may break the LCD module, handle the LCD module with care. Peel a protection sheet off from the LCD panel surface as slowly as possible.
- As the LCD panel and back - light element are made from fragile glass material, impulse and pressure to the LCD module should be avoided.
- As the surface of the polarizer is very soft and easily scratched, use a soft dry cloth without chemicals for cleaning.
- Do not pull the interface connector in or out while the LCD module is operating.
- Put the module display side down on a flat horizontal plane.
- Handle connectors and cables with care.

### (3) Cautions for the operation

- When the module is operating, do not lose CLK, ENAB signals. If any one of these signals is lost, the LCD panel would be damaged.
- Obey the supply voltage sequence. If wrong sequence is applied, the module would be damaged.
- Ultra-violet ray filter is necessary for outdoor operation
- If the product will be used in extreme conditions such as high temperature, humidity, display patterns, operation time, etc., it is strongly recommended to contact BOE for application engineering device. Otherwise, the reliability and function of the module may not be guaranteed. Extreme conditions are commonly found at airports, transit stations, banks, stocks, markets, and controlling systems.

### (4) Cautions for the atmosphere

- Dew drop atmosphere should be avoided.
- Do not store and/or operate the LCD module in a high temperature and/or humidity atmosphere. Storage in an electro-conductive polymer packing pouch and under relatively low temperature atmosphere is recommended.

### (5) Cautions for the module characteristics

- Do not apply fixed pattern data signal to the LCD module at product aging.
- Applying fixed pattern for a long time may cause image sticking.

**12.0 HANDLING & CAUTIONS**

## (6) Other cautions

- Do not disassemble and/or re-assemble LCD module.
- Do not re-adjust variable resistor or switch etc.
- When returning the module for repair or etc., Please pack the module not to be broken. We recommend to use the original shipping packages.
- When this reverse model is used as a forward-type model (PCB on top side), BOE can not guarantee any defects of LCM.
- If LCD module containing system is out of BOE 's operating or storing condition, BOE can not guarantee LCD module operating properly.

## 13.0 PRODUCT SERIAL NUMBER

DP/N	MV215FHM-N72	B4	
XXXXXX			
XXXX	XXXXXXXXXXXXXXXXXXXXXX		  MADE IN CHINA
		REV A00	
XX-XXXXXX-XXXXX-XXX-XXXX			

MDL ID naming rule is:

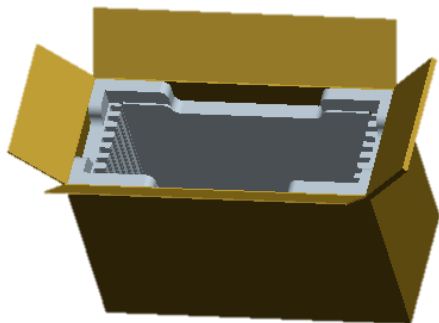
Digit	1	2	3	4	5	6						7						
Code	x	x	x	x	x	x	x	x	x	x	x	x	x	x	x	x	x	x
Des.	1. Control Number 2. Rank/Grade 3. Line Classification 4. Year(2001:01, 2002:02, ...) 5. Month(1, 2, 3, ..., 9, X, Y, Z) 6. Internal Use 7. Serial Number																	



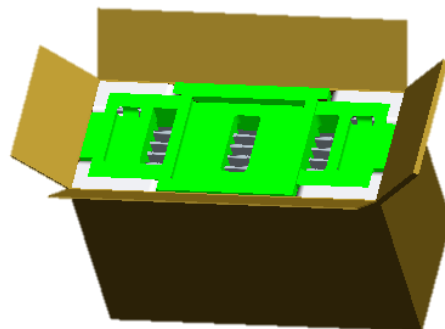
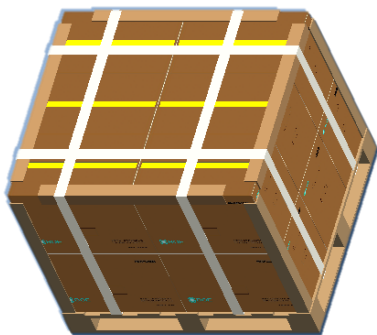
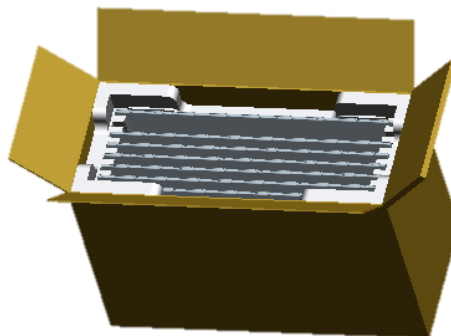
## 14.0 Packing

### 14.1 Packing Order

Put 1 EPO bottom into the inner box.



Put each module into a PE bag.  
Insert 10 Pcs MDL into each box



Place paper corners and wrap film around the boxes.  
Pack with 4 packing belts.

Put 1 EPO cover in and seal the box.

### 14.2 Packing Note

- Box Dimension : 563mm(W) × 338mm(L) × 390mm(H)
- Package Quantity in one Box : 10pcs

### 14.3 Box label

- Label Size : 110 mm (L) × 55 mm (W)
- Contents

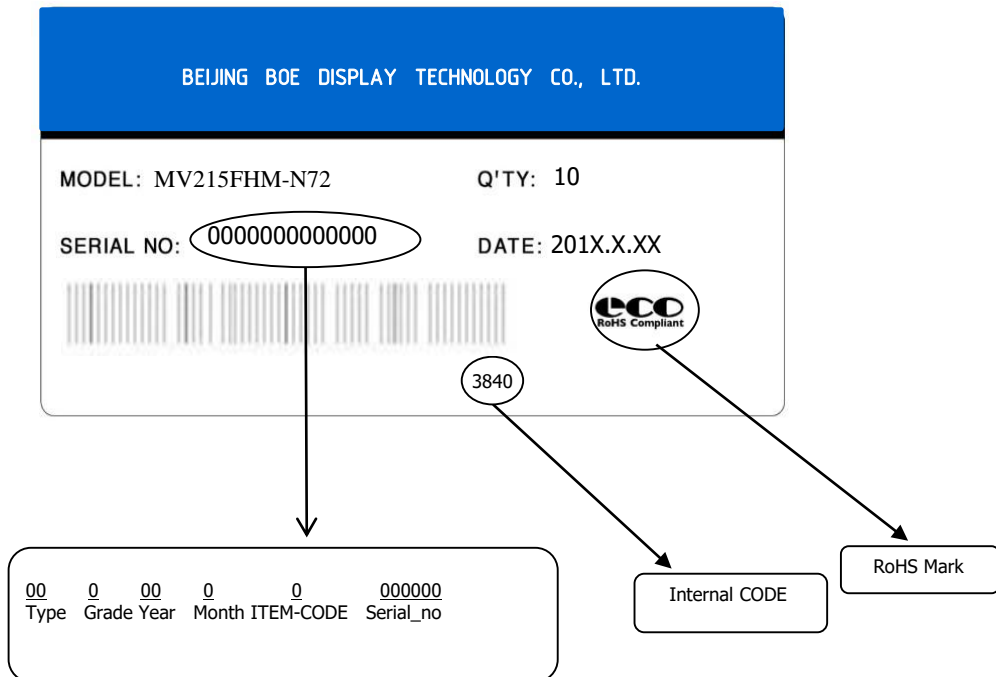
Model : MV215FHM-N72

Q`ty : Module 10 Q`ty in one box

Serial No. : Box Serial No. See next page for detail description.

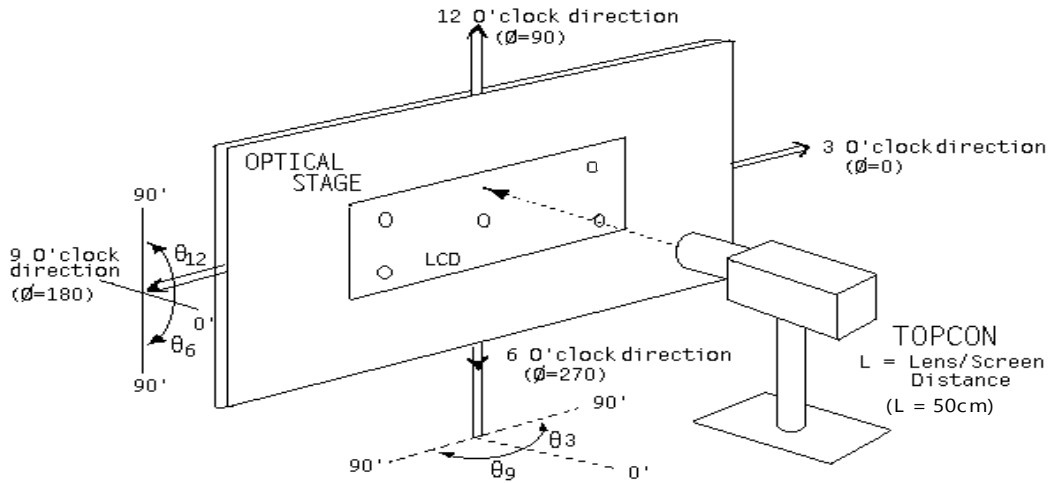
Date : Packing Date

FG Code : FG Code of Product

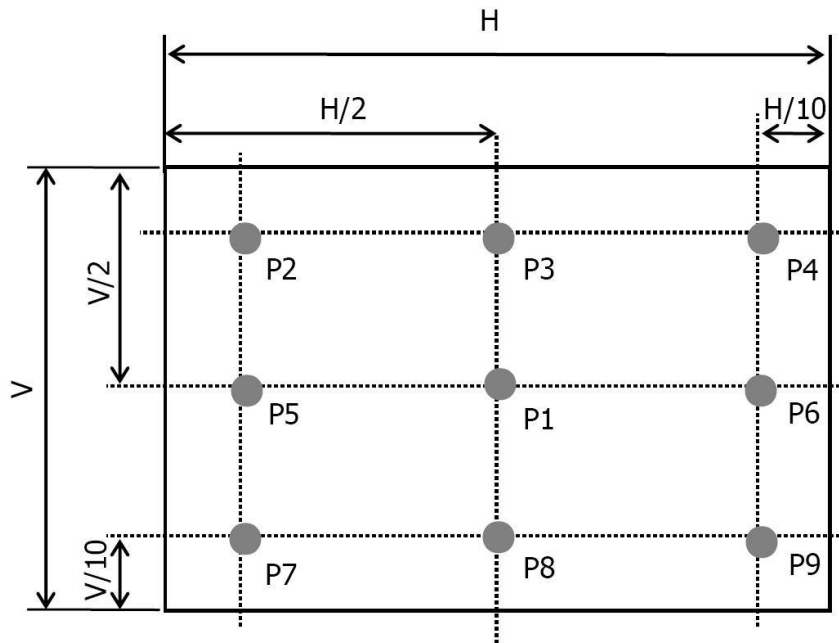


## 15.0 APPENDIX

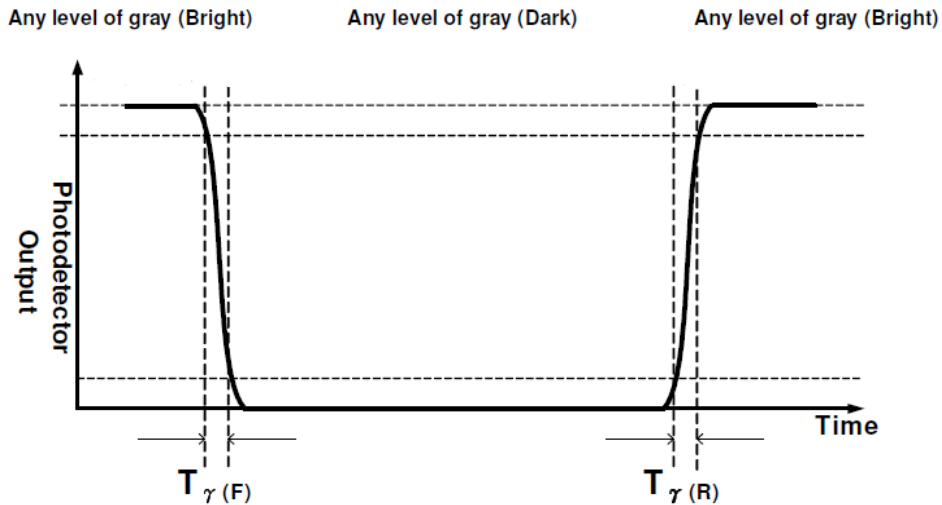
**Figure 1. Measurement Set Up**



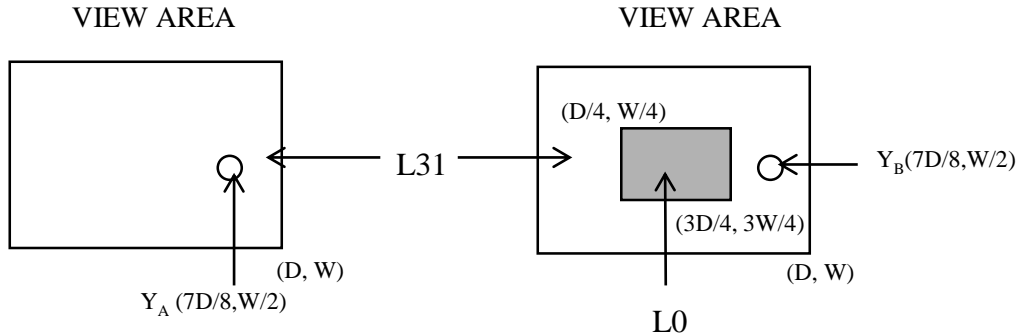
**Figure 2. White Luminance and Uniformity Measurement Locations (9 points)**



**Figure 3. Response Time Testing**



**Figure 4. Cross Modulation Test Description**



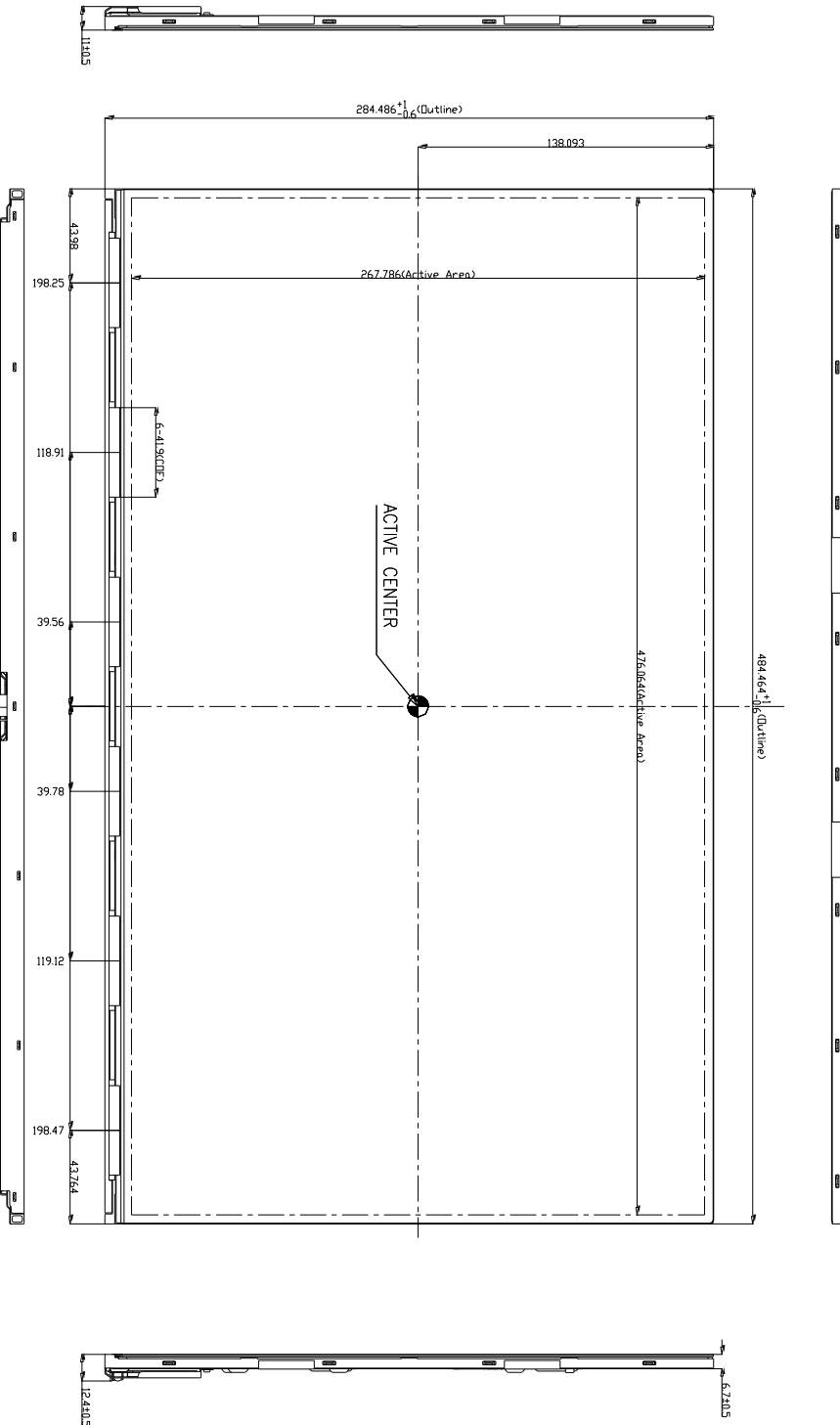
$$\text{Cross-Talk (\%)} = \left| \frac{Y_B - Y_A}{Y_A} \right| \times 100$$

Where:  $Y_A$  = Initial luminance of measured area (cd/m<sup>2</sup>)

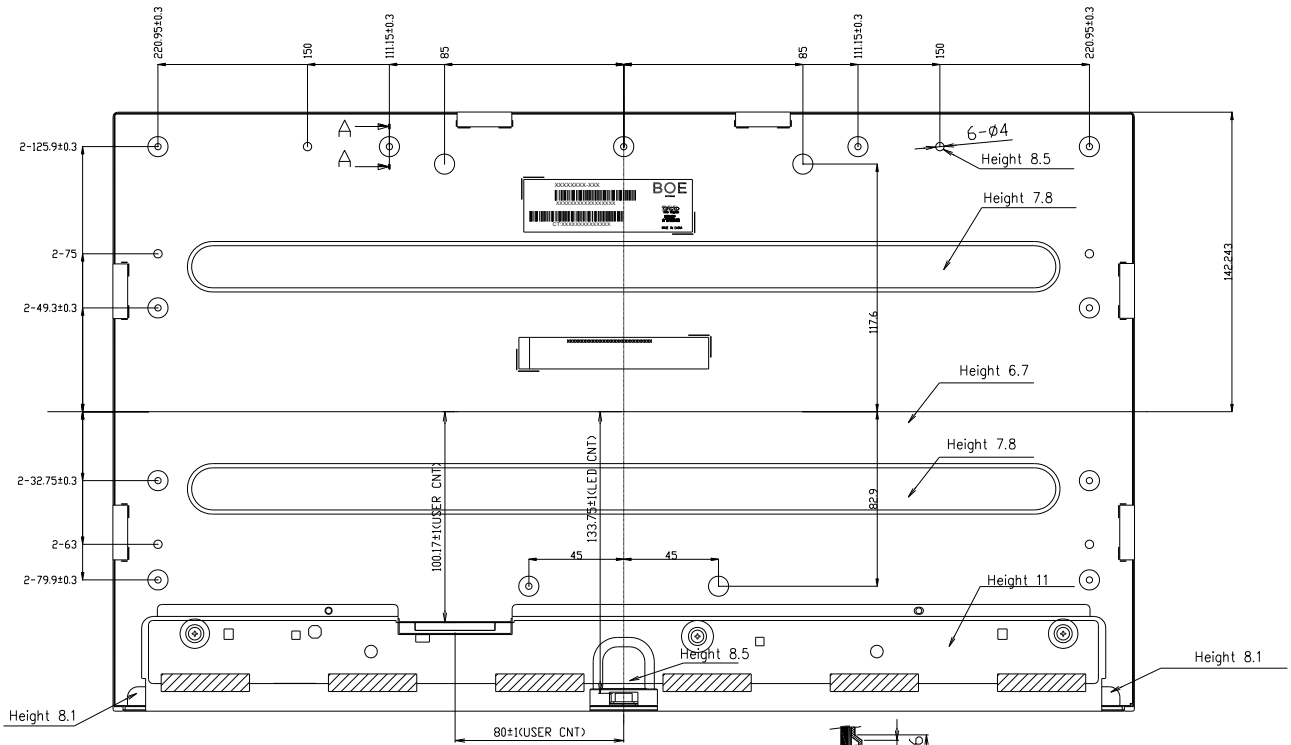
$Y_B$  = Subsequent luminance of measured area (cd/m<sup>2</sup>)

The location measured will be exactly the same in both patterns

**Figure 5. TFT-LCD Module Outline Dimensions (Front view)**

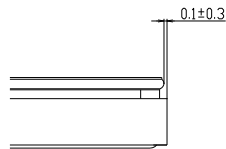


**Figure 6. TFT-LCD Module Outline Dimensions (Rear view)**



**NOTE:**

1. I/F CONNECTOR SPECIFICATION  
IS100-L300-C23(UJU) or EQUIVALENT
2. LED CONNECTOR SPECIFICATION  
BM06B-SHJS-TB(JST) or 10035WS-H06D(YEONHO) or EQUIVALENT
3. USER MOUNTING TORQUE SPEC : 3 ~ 4 kgf-cm  
Tilt and partial disposition tolerance of display area as following  
Measuring Tool: Feeler Gauge or Vernier Caliper



4. The CDF area is weak & sensitive, so please don't press the CDF Area