

TITLE : NV173FHM-N6K-8RA0**Customer:****Product Specification****Rev. 0****BOE Optoelectronics Technology Co., Ltd**

REVISION HISTORY

() Preliminary Specification

(√) Final Specification

Revision No.	Page	Description of Changes	Date	Prepared
0	-	Final Release	2023.05.15	Liu Jie

REVIEWED**Designer****Manager**

Wu Zhonshan(Array)

Wang Xiaoyuan

Teng Zhengyuan(Cell)

Li Zhe

Jiang Zhisheng(CF)

Li Min

Zhang Wendi(EE)

Shen Can

Qiu Rui(MO)

Luo Wencheng

Ding Guijie(DQA)

Cui Chaoyang

Chen Changyi(PI)

Cheng Gang

APPROVED

Liu Jie(PM)

Contents

No.	Items	Page
1.0	General Description	4
2.0	Absolute Maximum Ratings	6
3.0	Electrical Specifications	7
4.0	Optical Specifications	11
5.0	Interface Connection	15
6.0	Signal Timing Specification	16
7.0	Input Signals, Display Colors & Gray Scale of Colors	20
8.0	Power Sequence	26
9.0	Connector Description	27
10.0	Mechanical Characteristics	28
11.0	Reliability Test	29
12.0	Handling & Cautions	30
13.0	Label	31
14.0	Packing Information	33
15.0	Mechanical Outline Dimension	34
16.0	EDID Table	36
17.0	General Precautions	40
18.0	Appendix	42

1.0 GENERAL DESCRIPTION

1.1 Introduction

NV173FHM-N6K-8RA0 is a color active matrix TFT LCD module using amorphous silicon TFT's (Thin Film Transistors) as an active switching devices. This module has a 17.3 inch diagonally measured active area with Full-HD resolutions (1920 horizontal by 1080 vertical pixel array). Each pixel is divided into RED, GREEN, BLUE dots which are arranged in vertical stripe and this module can display 16.7M(8bit)colors and color gamut 72%. The TFT-LCD panel used for this module is a low reflection and higher color type. Therefore, this module is suitable for Notebook PC. The LED driver for back-light driving is built in this model.

All input signals are eDP1.2 interface compatible.

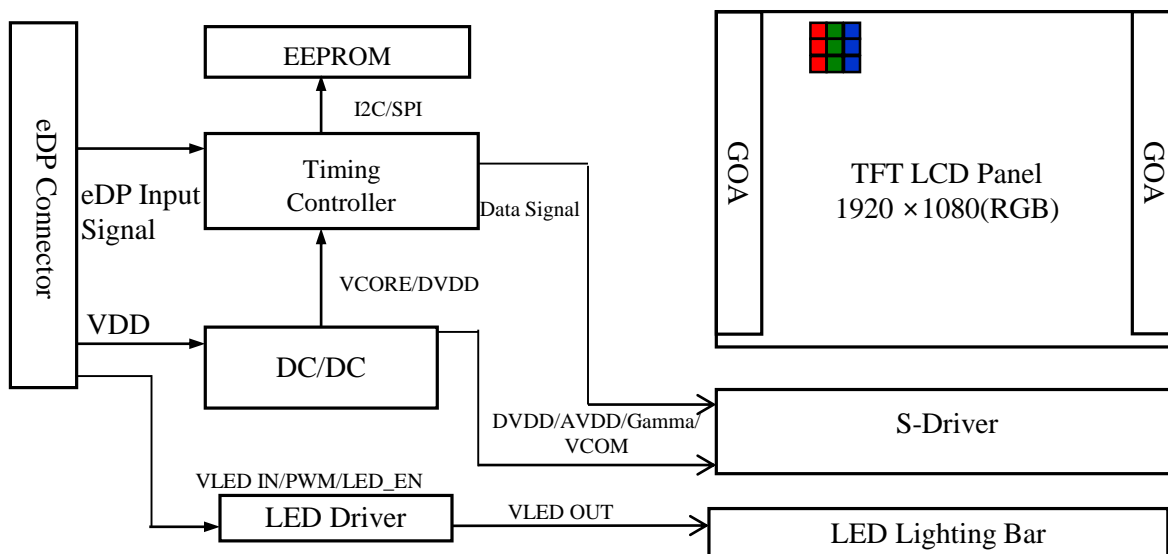

Figure 1. Drive Architecture

1.2 Features

- 2 lane eDP interface with 2.7Gbps link rates
- Thin and light weight
- 16.7M(8bit) color depth, color gamut 72%
- Single LED lighting bar (Bottom side/Horizontal Direction)
- Data enable signal mode
- Side mounting frame
- Green product (RoHS & Halogen free product)
- On board LED driving circuit
- Low driving voltage and low power consumption
- On board EDID chip
- DPCD Version 1.1
- Function : BIST/Free-sync

1.3 Application

- Notebook PC (Wide type)

1.4 General Specification

The followings are general specifications at the model NV173FHM-N6K-8RA0. (listed in Table 1)

<Table 1. General Specifications>

Parameter	Specification	Unit	Remarks
Active area	381.888(H) × 214.812(V)	mm	
Number of pixels	1920 (H) × 1080 (V)	pixels	
Pixel pitch	198.9(H) × 198.9(V)	um	
Pixel arrangement	RGB Vertical stripe		
Display colors	16.7M(8bit)		
Color gamut	72%		
Display mode	Normally black		
Dimensional outline	389.888(H)(Typ.)×227.012(V)(w/oPCB)(Typ.)×3.5(max) 389.888(H)(Typ.)×238.012(V)(w/PCB)(Typ.)×3.5(max)	mm	
Weight	500(max)	g	
Surface treatment	Anti-Glare		
Surface hardness	3H		
Back-light	Bottom edge side, 1-LED lighting bar type		Note 1
Power consumption	P_D : 1.5(Max.)	W	@Mosaic
	P_{BL} : 4.8(Max.)	W	@VLED=12V
	P_{Total} :6.3(Max.)	W	@Mosaic

Notes : 1. LED Lighting Bar (60*LED Array)

2.0 ABSOLUTE MAXIMUM RATINGS

The followings are maximum values which, if exceed, may cause faulty operation or damage to the unit. The operational and non-operational maximum voltage and current values are listed in Table 2.

< Table 2. Absolute Maximum Ratings >

Ta=25+/-2°C

Parameter	Symbol	Min.	Max.	Unit	Remarks
Power Supply Voltage	V _{DD}	-0.3	4.0	V	Note 1
eDP input Voltage	V _{eDP}	0	2.0	V	
Logic Supply Voltage	V _{IN}	V _{SS} -0.3	V _{DD} +0.3	V	
Operating Temperature	T _{OP}	0	+50	°C	Note 2
Storage Temperature	T _{ST}	-20	+60	°C	

Notes :

1. Permanent damage to the device may occur if maximum values are exceeded functional operation should be restricted to the condition described under normal operating conditions.
2. Temperature and relative humidity range are shown in the figure below.
90 % RH Max. (40 °C ≥ Ta) Maximum wet - bulb temperature at 39 °C or less. (Ta > 40 °C) No condensation.

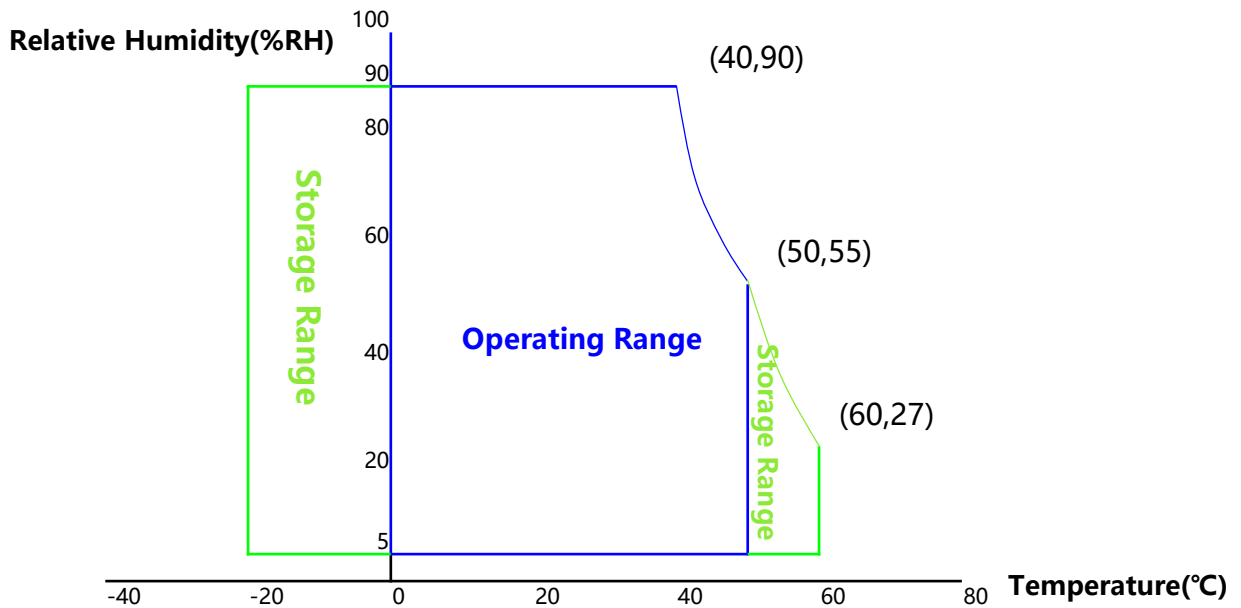

Figure 2. Temperature and Relative Humidity Range

3.0 ELECTRICAL SPECIFICATIONS

3.1 Electrical Specifications

< Table 3. Electrical Specifications >

Ta=25+/-2°C

Parameter		Min.	Typ.	Max.	Unit	Remarks	
Power Supply Voltage	V _{DD}	3.0	3.3	3.6	V	Note 1	
Permissible Input Ripple Voltage	V _{RF}	-10% VDD	-	+10% VDD	V	@ V _{DD} = 3.3V , note4	
BIST Control Level	High Level	1.44	-	3.3	V	@V _{DDIO} =1.8 V	
	Low Level	0	-	0.27	V		
Power Supply Inrush Current	Inrush	-	-	1.5	A	Note3	
Power Supply Current	Mosaic	I _{DD}	-	-	500	mA	Note 1
	RGB		-	-	667	mA	
Power Consumption	Mosaic	P _M	-	-	1.5	W	
	RGB	P _{RGB}	-	-	2	W	
	BLU	P _{BL}	-	-	4.8	W	Note 2
	Total	P _{Total}	-	-	6.3	W	@Mosaic

3.0 ELECTRICAL SPECIFICATIONS

3.1 Electrical Specifications

Notes :

1. The supply voltage is measured and specified at the interface connector of LCM.
The current draw and power consumption specified is for 3.3V at 25 °C.

- a) Mosaic pattern 8*8
- b) R/G/B patterns
- c) Solid pattern(maximum logic power consumption) : sub v line

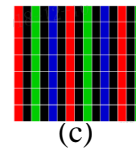
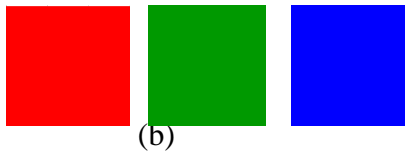
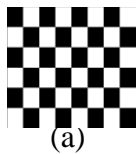

Figure 3. Power Measure Patterns

2. Calculated value for reference ($V_{LED} \times I_{LED}$) , The power consumption with LED Driver are under the $V_{LED} = 12.0V$, 25°C, PWM Duty 100% .

3. Measure condition (Figure 4)

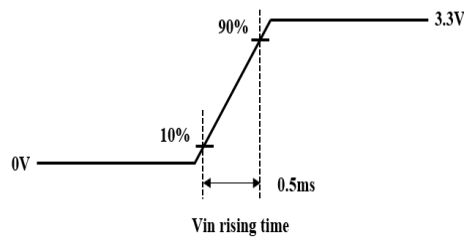

Figure 4. Inrush Measure Condition

4. Input voltage range:3.0~3.6V.Test condition: Oscilloscope bandwidth 20MHz, AC coupling

3.2 Backlight Unit

< Table 4. LED Driving Guideline Specifications >

Ta=25+/-2°C

Parameter		Min.	Typ.	Max.	Unit	Remarks	
LED Forward Voltage	V _F	-	-	3.0	V		
LED Forward Current	I _F	-	22.7	-	mA		
LED Power Input Voltage	V _{LED}	5	12	21	V		
LED Power Input Current	I _{LED}	-	-	179.2	mA	Note 1	
LED Power Consumption	P _{LED}	-	-	2.15	W		
Power Supply Voltage for LED Driver Inrush	I _{led} inrush	-	-	1.5	A	Note 3	
LED Life-Time	N/A	15,000	-	-	Hour	I _F = 22.7mA Note 2	
EN Control Level	Backlight On	V _{BL_EN}	2.5	-	5.0	V	
	Backlight Off		0	-	0.5	V	
PWM Control Level	High Level	V _{BL_PWM}	2.5	-	5.0	V	
	Low Level		0	-	0.5	V	
PWM Control Frequency	F _{PWM}	200	-	10000	Hz		
Duty Ratio		1	-	100	%		

Notes :

- Power supply voltage 12V for LED driver.
Calculator value for reference $I_F \times V_F \times 60 / \text{driver efficiency} = P_{LED}$
- The LED life-time define as the estimated time to 50% degradation of initial luminous.
- Measure condition (Figure 5)

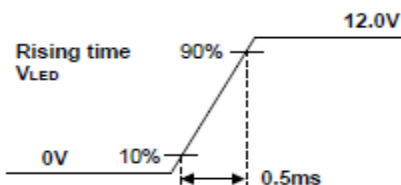

Figure 5. Inrush Measure Condition

3.3 LED Structure

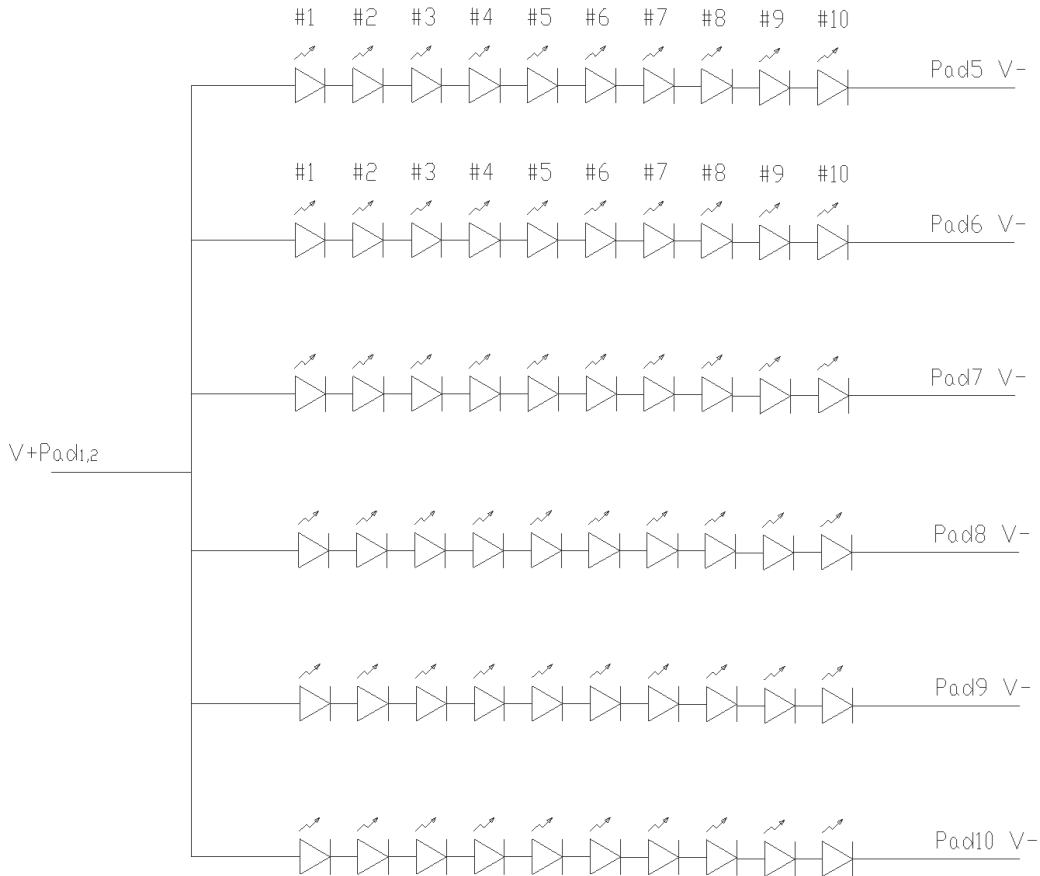

Figure 6. LED Structure

4.0 OPTICAL SPECIFICATION

4.1 Overview

The test of optical specifications shall be measured in a dark room (ambient luminance ≤ 1 lux and temperature = $25 \pm 2^\circ\text{C}$) with the equipment of luminance meter system (PR730&PR810) and test unit shall be located at an approximate distance 50cm from the LCD surface at a viewing angle of θ and Φ equal to 0° . We refer to $\theta=0$ ($=\theta_3$) as the 3 o'clock direction (the "right"), $\theta=90$ ($=\theta_{12}$) as the 12 o'clock direction ("upward"), $\theta=180$ ($=\theta_9$) as the 9 o'clock direction ("left") and $\theta=270$ ($=\theta_6$) as the 6 o'clock direction ("bottom"). While scanning θ and/or Φ , the center of the measuring spot on the display surface shall stay fixed. The backlight should be operating for 30 minutes prior to measurement. VDD shall be $3.3 \pm 0.3\text{V}$ at 25°C . Optimum viewing angle direction is 6 o'clock.

4.2 Optical Specifications

<Table 5. Optical Specifications>

Parameter		Symbol	Condition	Min.	Typ.	Max.	Unit	Remark
Viewing Angle Range	Horizontal	θ_3	CR > 10	80	85	-	Deg.	Note 1
		θ_9		80	85	-	Deg.	
	Vertical	θ_{12}		80	85	-	Deg.	
		θ_6		80	85	-	Deg.	
Luminance Contrast Ratio		CR	$\theta = 0^\circ$	900	1200	max		Note 2
Luminance of White	5 Points	Y_w	$\theta = 0^\circ$ $I_{LED} = 22.7\text{mA}$	255	300	-	cd/m^2	Note 3
White Luminance Uniformity	5 Points	ΔY_5		80	-	-	%	Note 4
	13 Points	ΔY_{13}		60	-	-	%	
White Chromaticity		W_x	$\theta = 0^\circ$	0.283	0.313	0.343		Note 5
		W_y		0.299	0.329	0.359		
Reproduction of Color	Red	R_x	$\theta = 0^\circ$	Typ.-0.03	0.640	Typ.+0.03		
		R_y			0.341			
	Green	G_x			0.320			
		G_y			0.624			
	Blue	B_x			0.156			
		B_y			0.058			
Color Gamut				68	72	-	%	NTSC 1931
Response Time (Rising + Falling)		T_{RT}	$T_a = 25^\circ\text{C}$ $\theta = 0^\circ$	-	16	25	ms	Note 6
Cross Talk		CT	$\theta = 0^\circ$	-	-	2.0	%	Note 7
Gamma		-	-	2.0	2.2	2.4	-	

Notes :

1. Viewing angle is the angle at which the contrast ratio is greater than 10. The viewing angles are determined for the horizontal or 3, 9 o'clock direction and the vertical or 6, 12 o'clock direction with respect to the optical axis which is normal to the LCD surface (see Figure 7).
2. Contrast measurements shall be made at viewing angle of $\Theta = 0$ and at the center of the LCD surface. Luminance shall be measured with all pixels in the view field set first to white, then to the dark (black) state . (see Figure 7) Luminance Contrast Ratio (CR) is defined mathematically.

$$CR = \frac{\text{Luminance when displaying a white raster}}{\text{Luminance when displaying a black raster}}$$
3. Center Luminance of white is defined as luminance values of 5 point average across the LCD surface. Luminance shall be measured with all pixels in the view field set first to white. This measurement shall be taken at the locations shown in Figure 8 for a total of the measurements per display.
4. The White luminance uniformity on LCD surface is then expressed as : $\Delta Y = \text{Minimum Luminance of 5(or 13) points} / \text{Maximum Luminance of 5(or 13) points.}$ (see Figure 8 and Figure 9).
5. The color chromaticity coordinates specified in Table 5 shall be calculated from the spectral data measured with all pixels first in red, green, blue and white. Measurements shall be made at the center of the panel.
6. The electro-optical response time measurements shall be made as Figure 10 by switching the “data” input signal ON and OFF. The times needed for the luminance to change from 10% to 90% is T_r , and 90% to 10% is T_r .
7. Cross-Talk of one area of the LCD surface by another shall be measured by comparing the luminance (YA) of a 25mm diameter area, with all display pixels set to a gray level, to the luminance (YB) of that same area when any adjacent area is driven dark. (See Figure 11).

4.3 Optical Measurements

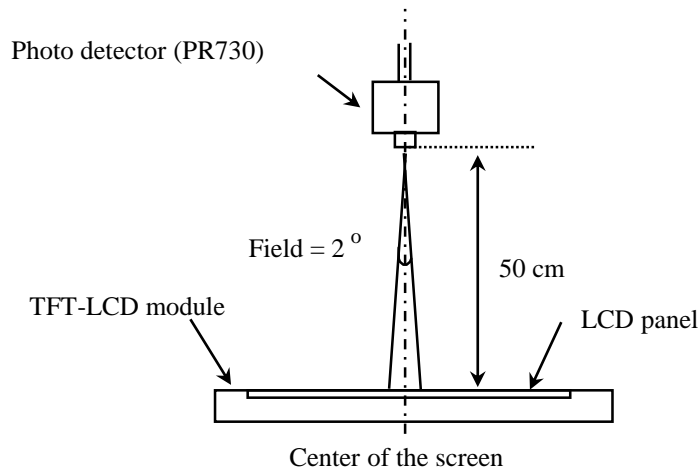

Optical characteristics measurement setup

Figure 7. Measurement Set Up

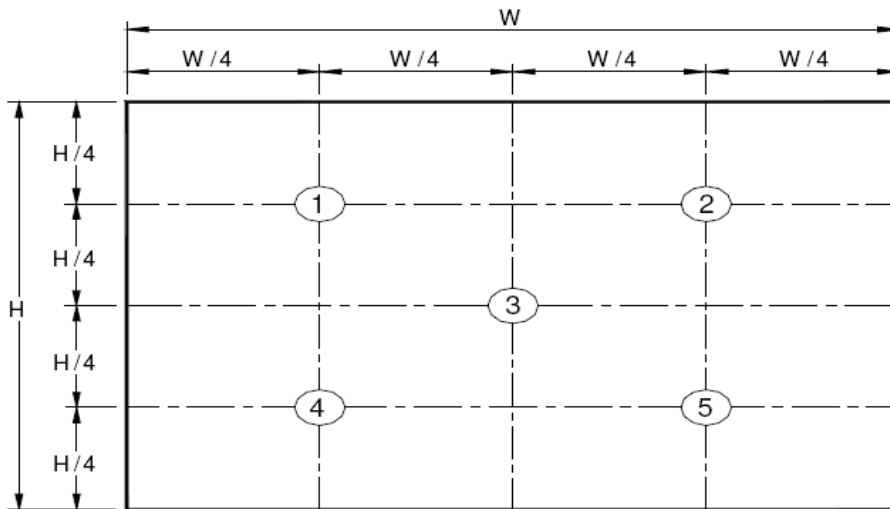

Figure 8. White Luminance and Uniformity Measurement Locations (5 points)

Center Luminance of white is defined as luminance values of center 5 points across the LCD surface. Luminance shall be measured with all pixels in the view field set first to white. This measurement shall be taken at the locations shown in Figure 7 for a total of the measurements per display.

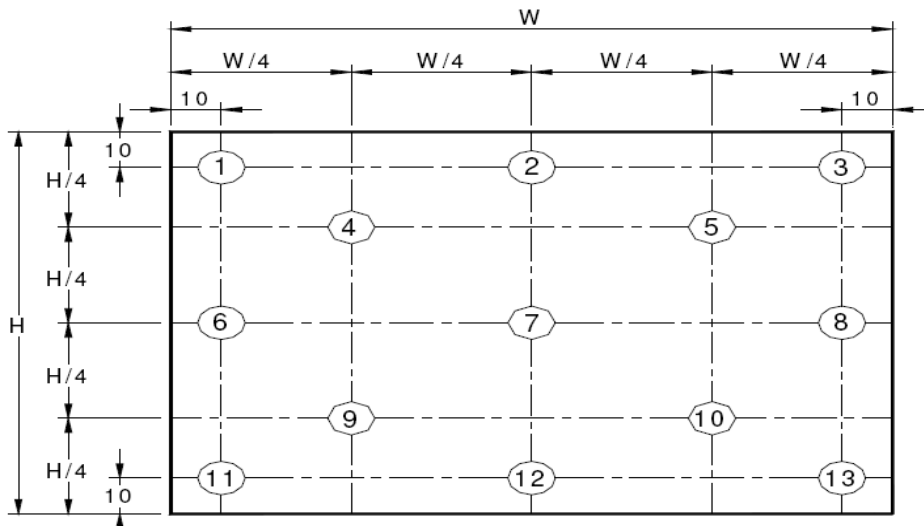

Figure 9. Uniformity Measurement Locations (13 points)

The White luminance uniformity on LCD surface is then expressed as : $\Delta Y5 = \text{Minimum Luminance of five points} / \text{Maximum Luminance of five points}$ (see Figure 8) , $\Delta Y13 = \text{Minimum Luminance of 13 points} / \text{Maximum Luminance of 13 points}$ (see Figure 9).

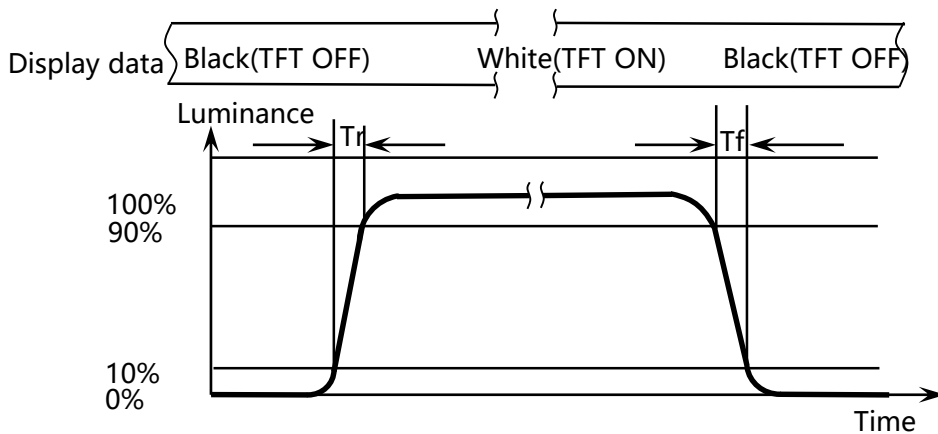
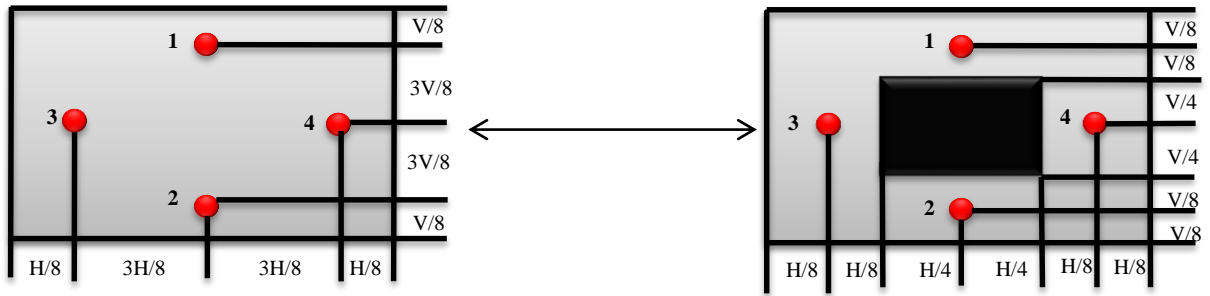

Figure 10. Response Time Testing

The electro-optical response time measurements shall be made as shown in Figure 10 by switching the “data” input signal ON and OFF. Tr: The luminance to change from 10% to 90% ,Tf: The luminance to change from 90% to 10% .

The test system : LMS PR810



$$\text{Cross Talk (\%)} = \left| \frac{Y_B - Y_A}{Y_A} \right| \times 100$$

Figure 11. Cross Talk Modulation Test Description

Where:

Y_A = Initial luminance of measured area (cd/m²)

Y_B = Subsequent luminance of measured area (cd/m²)

The location 1/2/3/4 measured will be exactly the same in both patterns. The test background gray is from L64 to L192. Take the largest data as the result.

Cross Talk of one area of the LCD surface by another shall be measured by comparing the luminance (Y_A) of a 25mm diameter area, with all display pixels set to a gray level, to the luminance (Y_B) of that same area when any adjacent area is driven dark. (Refer to Figure 11)

The test system: PR730

5.0 INTERFACE CONNECTION

5.1 Electrical Interface Connection

The electronics interface connector is UJU IS050-L30B-C10..

The connector interface pin assignments are listed in Table 6.

<Table 6. Pin Assignments for the Interface Connector>

Terminal	Symbol	Functions
Pin No.	Symbol	Description
1	CABC_EN	Disable
2	H_GND	Ground
3	LANE1_N	eDP RX Channel 1 Negative
4	LANE1_P	eDP RX Channel 1 Positive
5	H_GND	Ground
6	LANE0_N	eDP RX Channel 0 Negative
7	LANE0_P	eDP RX Channel 0 Positive
8	H_GND	Ground
9	AUX_CH_P	eDP AUX CH Positive
10	AUX_CH_N	eDP AUX CH Negative
11	H_GND	Ground
12	LCD_VCC	Power Supply, 3.3V (typ.)
13	LCD_VCC	Power Supply, 3.3V (typ.)
14	BIST	Panel Self Test Enable
15	H_GND	Ground
16	H_GND	Ground
17	HPD	Hot Plug Detect Output
18	BL_GND	LED Ground
19	BL_GND	LED Ground
20	BL_GND	LED Ground
21	BL_GND	LED Ground
22	BL_ENABLE	LED Enable Pin(+3.3V Input)
23	BL_PWM	System PWM Signal Input
24	NC	No Connection
25	NC	No Connection
26	BL_POWER	LED Power Supply 5V-21V
27	BL_POWER	LED Power Supply 5V-21V
28	BL_POWER	LED Power Supply 5V-21V
29	BL_POWER	LED Power Supply 5V-21V
30	NC	No Connection

5.2 eDP Interface

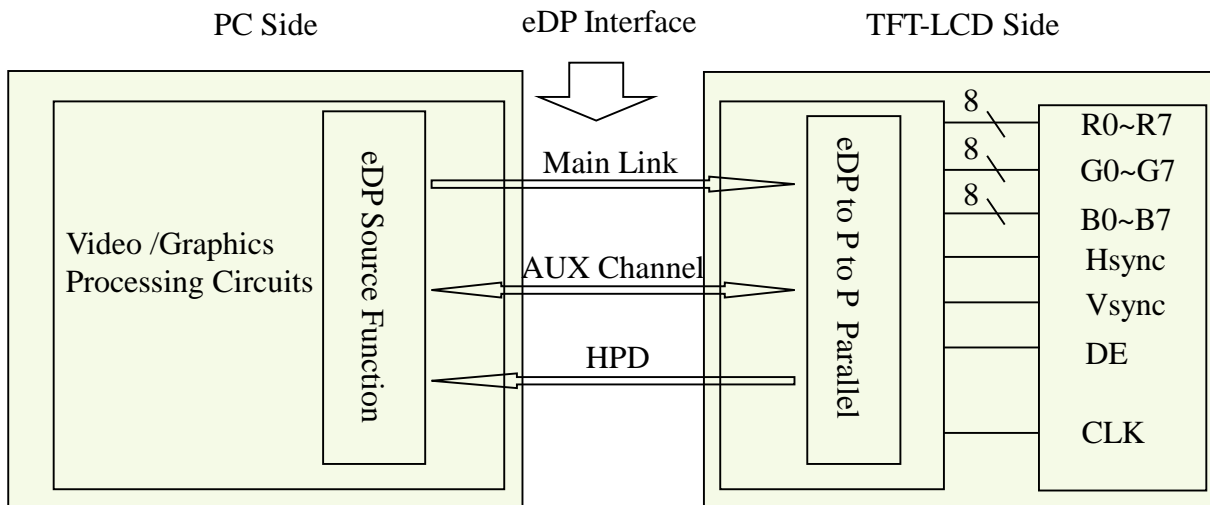

Figure 12. eDP Interface Architecture

Note:

Transmitter : Parade DP501 or equivalent.

Transmitter is not contained in module.

5.3 Data Input Format

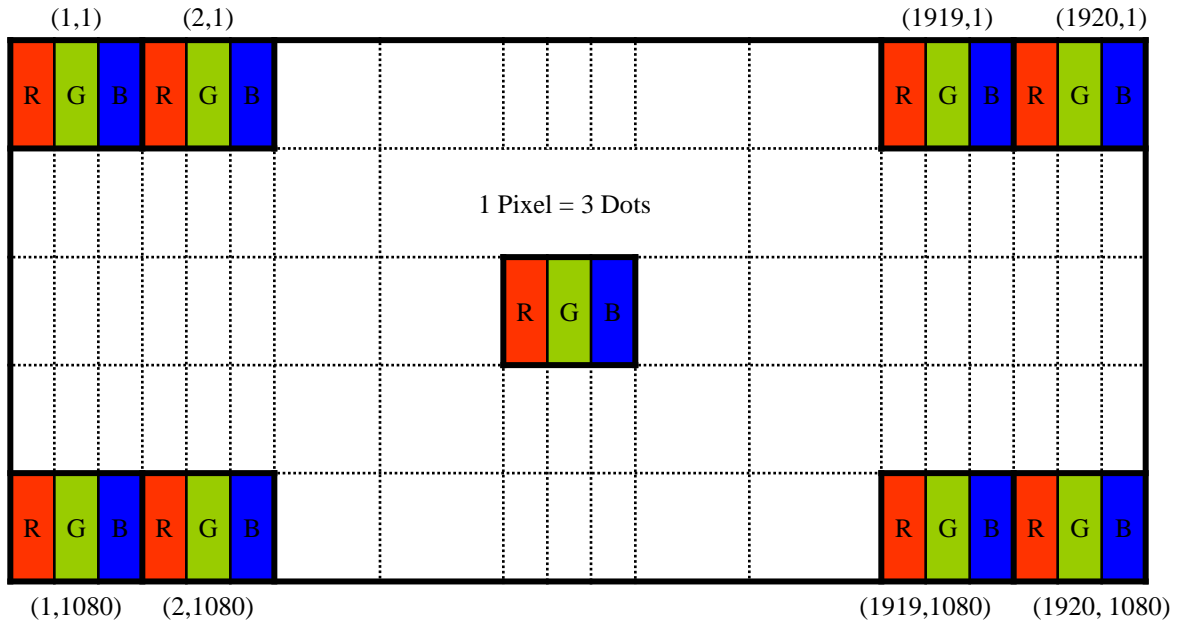

Figure 13. Display Position of Input Data (V-H)

5.4 Back-light & LCM Interface Connection

BLU Interface Connector: STM MSK24022P10D or Compatible.

<Table 7. Pin Assignments for the BLU Connector>

Pin No.	Symbol	Description	Pin No.	Symbol	Description
1	LED	LED cathode connection	6	LED	LED cathode connection
2	LED	LED cathode connection	7	NC	No Connection
3	LED	LED cathode connection	8	NC	No Connection
4	LED	LED cathode connection	9	Vout	LED anode connection
5	LED	LED cathode connection	10	Vout	LED anode connection

6.0 SIGNAL TIMING SPECIFICATION

6.1 The NV173FHM-N6K-8RA0 Is Operated By The DE Only

< Table 8. Signal Timing Specification >

Item		Symbols	Min	Typ	Max	Unit
Clock	Frequency	1/Tc	143.0	143.9	144.9	MHz
Frame Period		Tv	1115	1120	1125	lines
			-	60	-	Hz
			-	16.67	-	ms
Vertical Display Period		Tvd	-	1080	-	lines
One line Scanning Period		Th	2137	2142	2147	clocks
Horizontal Display Period		Thd	-	1920	-	clocks

Note : The above is as optimized setting.

6.2 eDP Rx Interface Timing Parameter

The specification of the eDP Rx interface timing parameter is shown in Table 9.

<Table 9. eDP Main-Link RX TP4 Package Pin Parameters>

Item	Symbol	Min	Typ	Max	Unit	Remark
Spread spectrum clock (Link clock down-spreading)	ssc	-	-	0.5	%	
Differential peak-to-peak input voltage at package pins	VRX-DIFFp-p	120	-	1200	mV	
Rx input DC common mode voltage	VRX_DC_CM	0	-	2	V	
Differential termination resistance	RRX-DIFF	90	100	110	Ω	
Single-ended termination resistance	RRX-SE	40	-	60	Ω	
Rx short circuit current limit	IRX_SHORT	-	-	50	mA	
Intra-pair skew at Rx package pins (HBR) RX intra-pair skew tolerance at HBR	LRX_SKEW_INTRA_PAIR	-	-	60	ps	
AC Coupling Capacitor	C _{SOURCE_ML}	75		200	nF	Source side

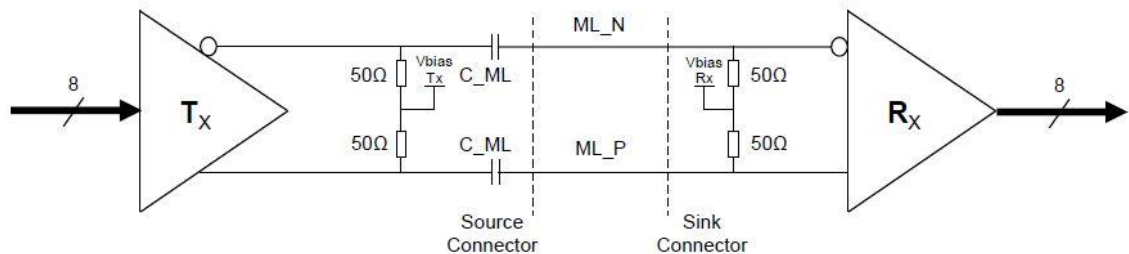

Figure 14. Main link differential pair

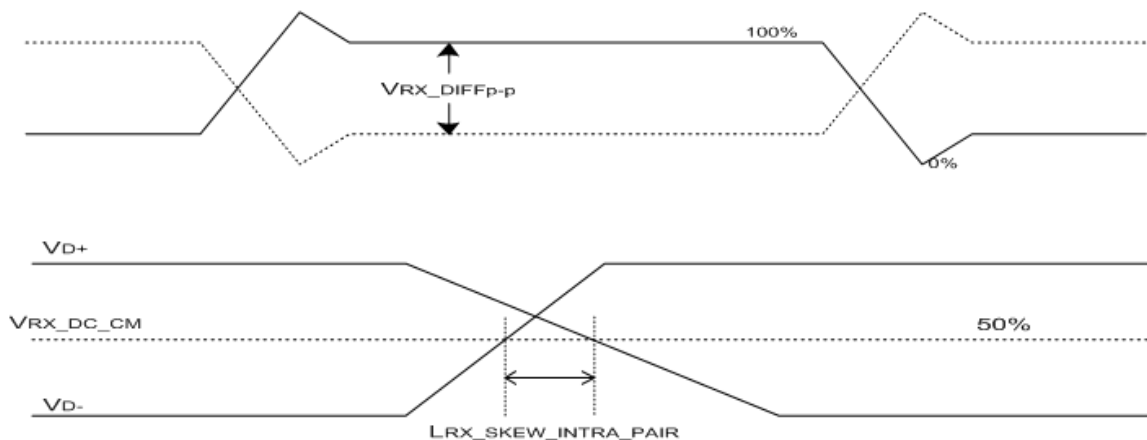

Figure 15. VRX-DIFFp-p & LRX_SKEW_INTRA_PAIR

<Table 10. HPD Characteristics>

Item	Symbol	Min	Typ	Max	Unit	Remark
HPD voltage	V _{HPD}	2.25	-	3.6	V	
Hot Plug Detection Threshold	-	2.0	-	-	V	Source side Detecting
Hot Unplug Detection Threshold	-	-	-	0.8V	V	
HPD_IRQ Pulse Width	HPD_IRQ	0.5	-	1	ms	
HPD_TimeOut	-	2.0	-	-	ms	

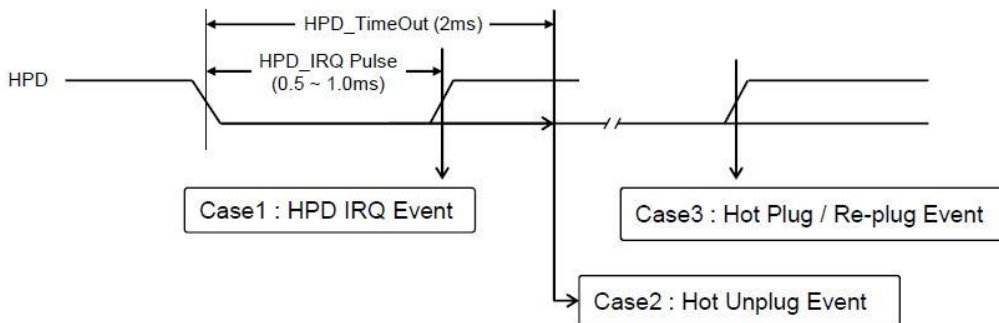

Figure 16. HPD Events

<Table 11. AUX Characteristics>

Item	Symbol	Min	Typ	Max	Unit	Remark
AUX unit interval	UIAUX	0.4	0.5	0.6	Us	
AUX peak-to-peak input differential voltage	VAUX-RX-DIFFp-p	0.29	-	1.38	V	
AUX CH termination DC resistance	RAUX-TERM	80	100	120	Ohm	
AUX DC common mode voltage	VAUX-DC-CM	0	-	2	V	
AUX turn around common mode voltage	VAUX-TURN-CM	-	-	0.3	V	
AUX short circuit current limit	IAUX-SHORT	-	-	90	mA	
AUX AC Coupling Capacitor	CSOURCE-AUX	75	-	200	nf	Source side

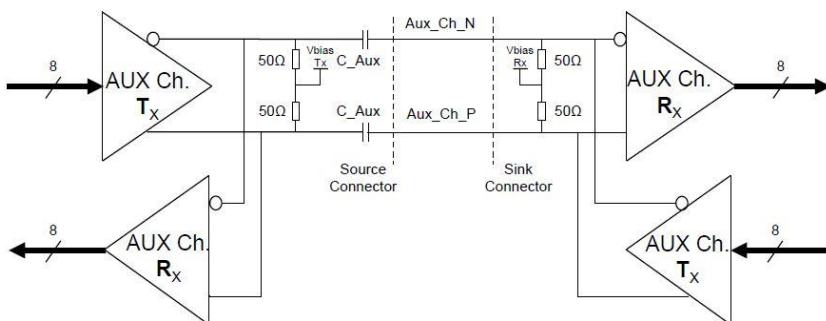

Figure 17. AUX differential pair

7.0 INPUT SIGNALS, BASIC DISPLAY COLORS & GRAY SCALE OF COLORS

<Table 12. Input Signal & Basic Display Colors & Gray Scale of Colors >

	Colors & Gray scale	Data signal															
		R0 R1 R2 R3 R4 R5 R6 R7	G0 G1 G2 G3 G4 G5 G6 G7	B0 B1 B2 B3 B4 B5 B6 B7													
Basic colors	Black	0 0 0 0 0 0 0 0	0 0 0 0 0 0 0 0	0 0 0 0 0 0 0 0													
	Blue	0 0 0 0 0 0 0 0	0 0 0 0 0 0 0 0	1 1 1 1 1 1 1 1													
	Green	0 0 0 0 0 0 0 0	1 1 1 1 1 1 1 1	0 0 0 0 0 0 0 0													
	Light Blue	0 0 0 0 0 0 0 0	1 1 1 1 1 1 1 1	1 1 1 1 1 1 1 1													
	Red	1 1 1 1 1 1 1 1	0 0 0 0 0 0 0 0	0 0 0 0 0 0 0 0													
	Purple	1 1 1 1 1 1 1 1	0 0 0 0 0 0 0 0	1 1 1 1 1 1 1 1													
	Yellow	1 1 1 1 1 1 1 1	1 1 1 1 1 1 1 1	0 0 0 0 0 0 0 0													
	White	1 1 1 1 1 1 1 1	1 1 1 1 1 1 1 1	1 1 1 1 1 1 1 1													
Gray scale of Red	Black	0 0 0 0 0 0 0 0	0 0 0 0 0 0 0 0	0 0 0 0 0 0 0 0													
	△	1 0 0 0 0 0 0 0	0 0 0 0 0 0 0 0	0 0 0 0 0 0 0 0													
	Darker	0 1 0 0 0 0 0 0	0 0 0 0 0 0 0 0	0 0 0 0 0 0 0 0													
	△		↑														
	▽		↓														
	Brighter	1 0 1 1 1 1 1 1	0 0 0 0 0 0 0 0	0 0 0 0 0 0 0 0													
	▽	0 1 1 1 1 1 1 1	0 0 0 0 0 0 0 0	0 0 0 0 0 0 0 0													
	Red	1 1 1 1 1 1 1 1	0 0 0 0 0 0 0 0	0 0 0 0 0 0 0 0													
Gray scale of Green	Black	0 0 0 0 0 0 0 0	0 0 0 0 0 0 0 0	0 0 0 0 0 0 0 0													
	△	0 0 0 0 0 0 0 0	1 0 0 0 0 0 0 0	0 0 0 0 0 0 0 0													
	Darker	0 0 0 0 0 0 0 0	0 1 0 0 0 0 0 0	0 0 0 0 0 0 0 0													
	△		↑														
	▽		↓														
	Brighter	0 0 0 0 0 0 0 0	1 0 1 1 1 1 1 1	0 0 0 0 0 0 0 0													
	▽	0 0 0 0 0 0 0 0	0 1 1 1 1 1 1 1	0 0 0 0 0 0 0 0													
	Green	0 0 0 0 0 0 0 0	1 1 1 1 1 1 1 1	0 0 0 0 0 0 0 0													
Gray scale of Blue	Black	0 0 0 0 0 0 0 0	0 0 0 0 0 0 0 0	0 0 0 0 0 0 0 0													
	△	0 0 0 0 0 0 0 0	0 0 0 0 0 0 0 0	1 0 0 0 0 0 0 0													
	Darker	0 0 0 0 0 0 0 0	0 0 0 0 0 0 0 0	0 1 0 0 0 0 0 0													
	△		↑														
	▽		↓														
	Brighter	0 0 0 0 0 0 0 0	0 0 0 0 0 0 0 0	1 0 1 1 1 1 1 1													
	▽	0 0 0 0 0 0 0 0	0 0 0 0 0 0 0 0	0 1 1 1 1 1 1 1													
	Blue	0 0 0 0 0 0 0 0	0 0 0 0 0 0 0 0	1 1 1 1 1 1 1 1													
Gray scale of White& Black	Black	0 0 0 0 0 0 0 0	0 0 0 0 0 0 0 0	0 0 0 0 0 0 0 0													
	△	1 0 0 0 0 0 0 0	1 0 0 0 0 0 0 0	1 0 0 0 0 0 0 0													
	Darker	0 1 0 0 0 0 0 0	0 1 0 0 0 0 0 0	0 1 0 0 0 0 0 0													
	△		↑														
	▽		↓														
	Brighter	1 0 1 1 1 1 1 1	1 0 1 1 1 1 1 1	1 0 1 1 1 1 1 1													
	▽	0 1 1 1 1 1 1 1	0 1 1 1 1 1 1 1	0 1 1 1 1 1 1 1													
	White	1 1 1 1 1 1 1 1	1 1 1 1 1 1 1 1	1 1 1 1 1 1 1 1													

8.0 POWER SEQUENCE

To prevent a latch-up or DC operation of the LCD module, the power on/off sequence shall be as shown in below.

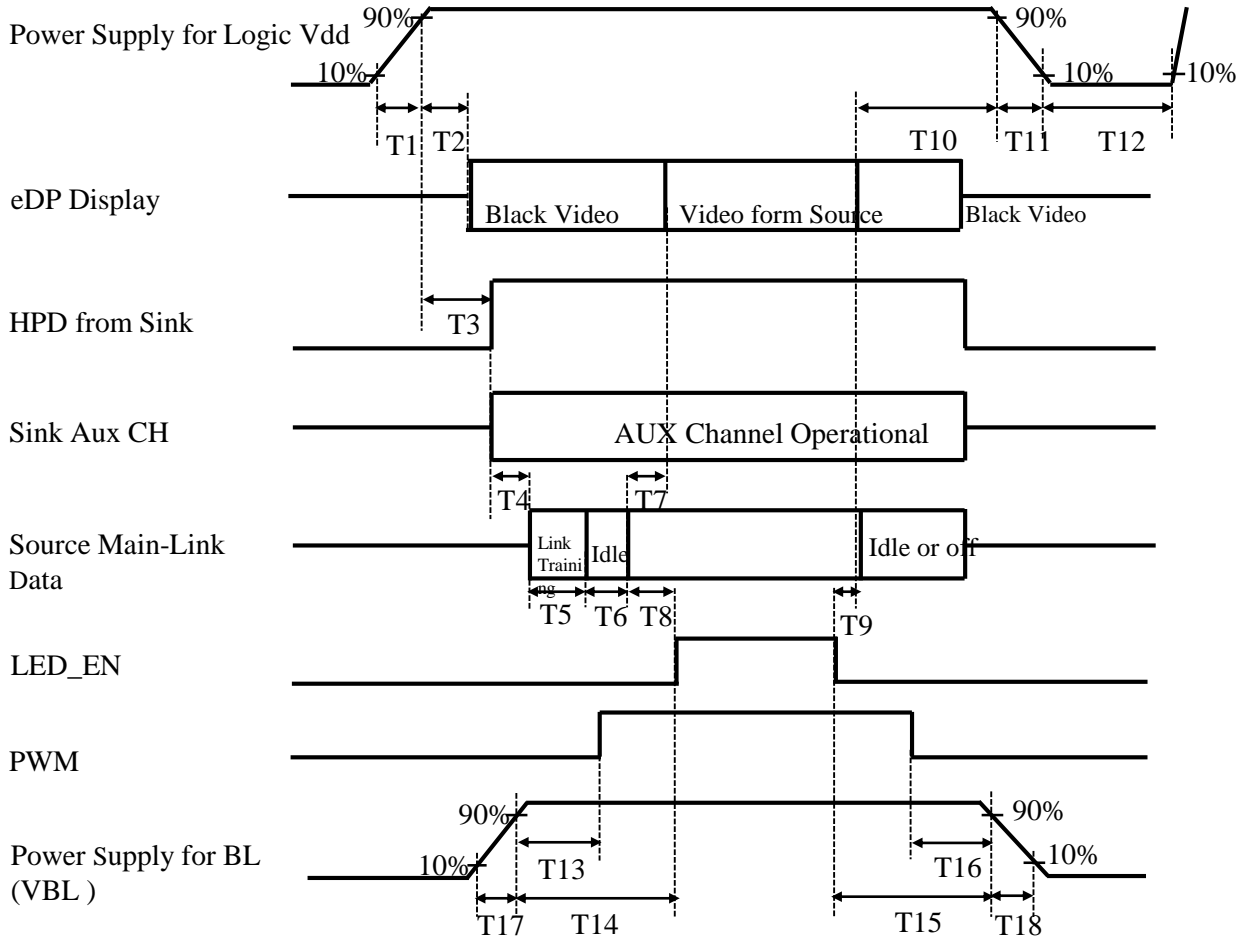

Figure 18. Power Sequence

- $0.5\text{ms} \leq T1 \leq 10\text{ms}$
- $0\text{ms} < T2 \leq 200\text{ms}$
- $0\text{ms} < T3 \leq 200\text{ms}$
- $T4+T5+T6+T8 > 80\text{ms}$
- $0\text{ms} < T7 \leq 50\text{ms}$
- $50\text{ms} < T8$
- $0\text{ms} < T9$
- $100\text{ms} < T10 < 500\text{ms}$
- $0.5\text{ms} \leq T11 \leq 10\text{ms}$
- $500\text{ms} \leq T12$
- $0\text{ms} < T13$
- $0\text{ms} < T14$
- $0\text{ms} < T15$
- $0\text{ms} < T16$
- $0.5\text{ms} \leq T17$
- $0.5\text{ms} \leq T18$

Notes:

- When the power supply VDD is 0V, keep the level of input signals on the low or keep high impedance.
- Do not keep the interface signal high impedance when power is on. Back Light must be turn on after power for logic and interface signal are valid.

Power Supply for Logic Vdd

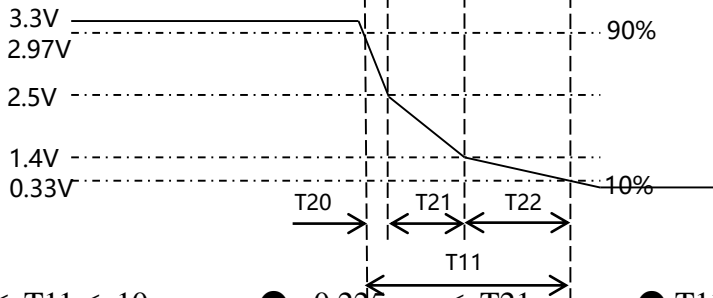

● $0.5\text{ms} \leq T11 \leq 10\text{ms}$

● $0.225\text{ms} \leq T21$

● $T11 = T20 + T21 + T22$

Figure 19. T11 timing requirements

9.0 Connector Description

Physical interface is described as for the connector on LCM.

These connectors are capable of accommodating the following signals and will be following components.

9.1 TFT LCD Module

< Table 13. Signal Connector >

Connector Name /Description	For Signal Connector
Manufacturer	UJU
Type/ Part Number	IS050-L30B-C10
Mating Housing/ Part Number	I-PEX 20454-030T

10.0 MECHANICAL CHARACTERISTICS

10.1 Dimensional Requirements

Figure 23 shows mechanical outlines for the model NV173FHM-N6K-8RA0. Other parameters are shown in Table 14.

<Table 14. Dimensional Parameters>

Parameter	Specification	Unit
Active Area	381.888(H) × 214.812(V)	mm
Number of pixels	1920 (H) × 1080 (V)	pixels
Pixel pitch	198.9(H) × 198.9(V)	um
Pixel arrangement	RGB Vertical stripe	
Display colors	16.7M(8bit)	
Display mode	Normally black	
Dimensional outline	389.888(H)(Typ.)×227.012(V)(w/oPCB)(Typ.)×3.5(max) 389.888(H)(Typ.)×238.012(V)(w/PCB)(Typ.)×3.5(max)	mm
Weight	500 (max)	g

10.2 Mounting

See Figure 24.

10.3 Anti-Glare and Polarizer Hardness.

The surface of the LCD has an Anti-Glare coating to minimize reflection and a coating to reduce scratching. **Polarizer Hardness is 3H.**

10.4 Light Leakage

There shall not be visible light from the back-lighting system around the edges of the screen as seen from a distance 50cm from the screen with an overhead light level of 350lux.

11.0 RELIABILITY TEST

The reliability test items and its conditions are shown in below.

<Table 15. Reliability Test>

No	Test Items	Conditions	Remark
1	High temperature storage test	Ta = 60°C , 60%RH, 120 hrs	
2	Low temperature storage test	Ta = -20°C , 120 hrs	
3	High temperature & high humidity operation test	Ta = 50°C , 80%RH, 120 hrs	
4	High temperature operation test	Ta = 50°C , 60%RH, 120 hrs	
5	Low temperature operation test	Ta = -5°C , 120 hrs	
6	Thermal shock	Ta = -20 °C ↔ 60 °C (0.5 hr), 60% ±3%RH, 50 cycle	
7	Vibration test (non-operating)	Ta = 25°C , 60%RH, 1.5G, 10~500Hz, Sine X,Y,Z / Sweep rate : 1 hour	Note 1
8	Shock test (non-operating)	Ta = 25°C , 60%RH, 220G, Half Sine Wave 2msec±X,±Y,±Z Once for each direction	Note 1
9	Electro-static discharge test (operating)	Air : 150 pF, 330Ω, ±8KV Contact : 150 pF, 330Ω, ±4KV Ta = 25°C , 60%RH,	Note 2

Notes :

1. The fixture must be hard enough , so that the module would not be twisted or bent.
2. Self- recovery and restart recovery is allowed. No hardware failures.

12.0 HANDLING & CAUTIONS

(1) Cautions when taking out the module

- Pick the pouch only, when taking out module from a shipping package.

(2) Cautions for handling the module

- As the electrostatic discharges may break the LCD module, handle the LCD module with care. Peel a protection sheet off from the LCD panel surface as slowly as possible.
- As the LCD panel and back - light element are made from fragile glass material, impulse and pressure to the LCD module should be avoided.
- As the surface of the polarizer is very soft and easily scratched, use a soft dry cloth without chemicals for cleaning.
- Do not pull the interface connector in or out while the LCD module is operating.
- Put the module display side down on a flat horizontal plane.
- Handle connectors and cables with care.

(3) Cautions for the operation

- When the module is operating, do not lose CLK, ENAB signals. If any one of these signals is lost, the LCD panel would be damaged.
- Obey the supply voltage sequence. If wrong sequence is applied, the module would be damaged.

(4) Cautions for the atmosphere

- Dew drop atmosphere should be avoided.
- Do not store and/or operate the LCD module in a high temperature and/or humidity atmosphere. Storage in an electro-conductive polymer packing pouch and under relatively low temperature atmosphere is recommended.

(5) Cautions for the module characteristics

- Do not apply fixed pattern data signal to the LCD module at product aging.
- Applying fixed pattern for a long time may cause image sticking.

(6) Other cautions

- Do not disassemble and/or re-assemble LCD module.
- Do not re-adjust variable resistor or switch etc.
- When returning the module for repair or etc. Please pack the module not to be broken. We recommend to use the original shipping packages.

13.0 LABEL

(1) Product Label

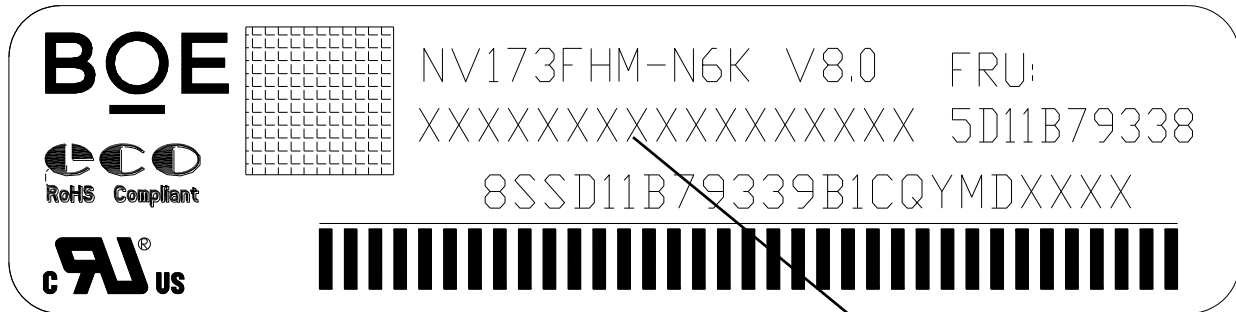

Figure 20. Product Label

Module ID Naming Rule:

<Table 16. Module ID Naming Rule>

Digit Code	1	2	3	4	5	6	7	8	9	10	11	12	13	14	15	16	17
Code	B	9	A	F	1	7	8	8	D	3	1	0	0	0	0	6	8
Description	Product Name		Product Grade	B8	Year	Month	Model Extension Code (Last 4 Digits of FG CODE)				Serial No. 00001-ZZZZZ						

(2) High voltage caution label

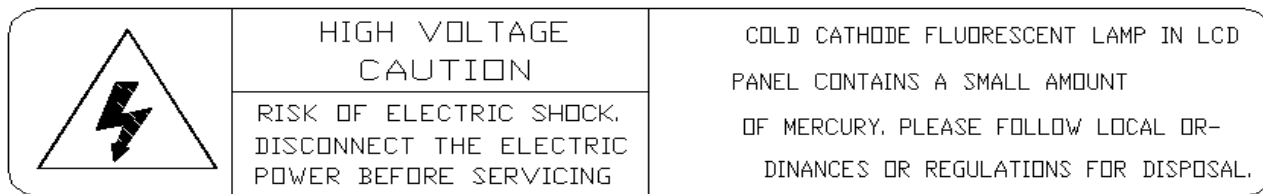

Figure 20. High Voltage Caution Label

(3) Box label



Figure 21. Box Label

Serial number marked part needs to print, show as follows:

1. FG-CODE(Before 12 bit)
2. Product quantity
3. Box ID
4. Date
5. The client section material number(The client)
6. FG-Code After four
7. The supplier code

Total Size:100×60mm

<Table 17. Box Label Naming Rule >

Digit Code	1	2	3	4	5	6	7	8	9	10	11	12	13
Code	B	9	A	F	1	7	8	N	0	0	3	2	7
Description	Product Name		Product Grade	B8	Year		Month	Revision	BOX Serial Number				

14.0 PACKING INFORMATION

14.1 Packing Order

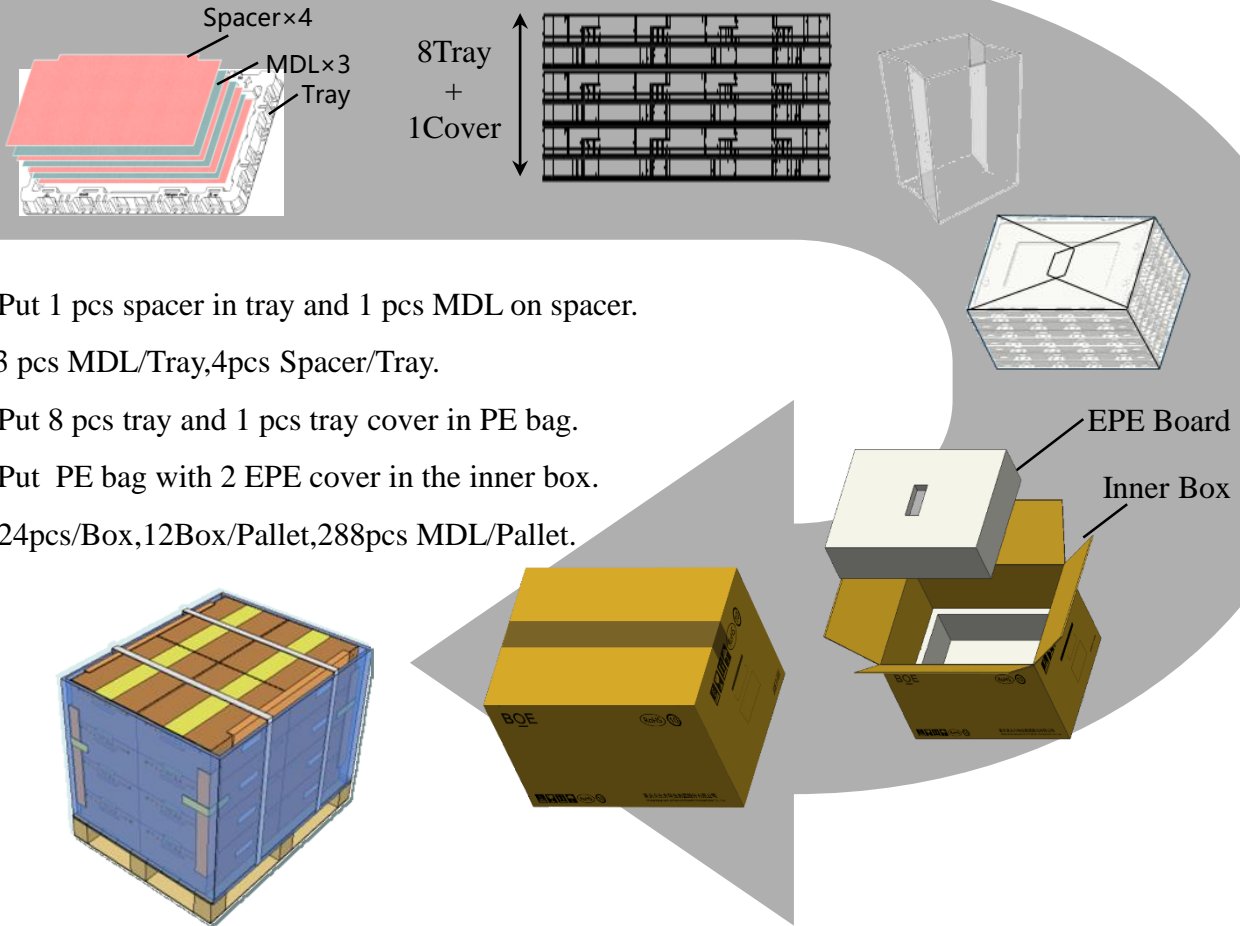

Figure 23. Packing Order

14.2 Note

- Box dimension: 522mm*392mm*294mm
- Package quantity in one box: 24 pcs
- Total weight: 15.1 kg/Box

15.0 MECHANICAL OUTLINE DIMENSION

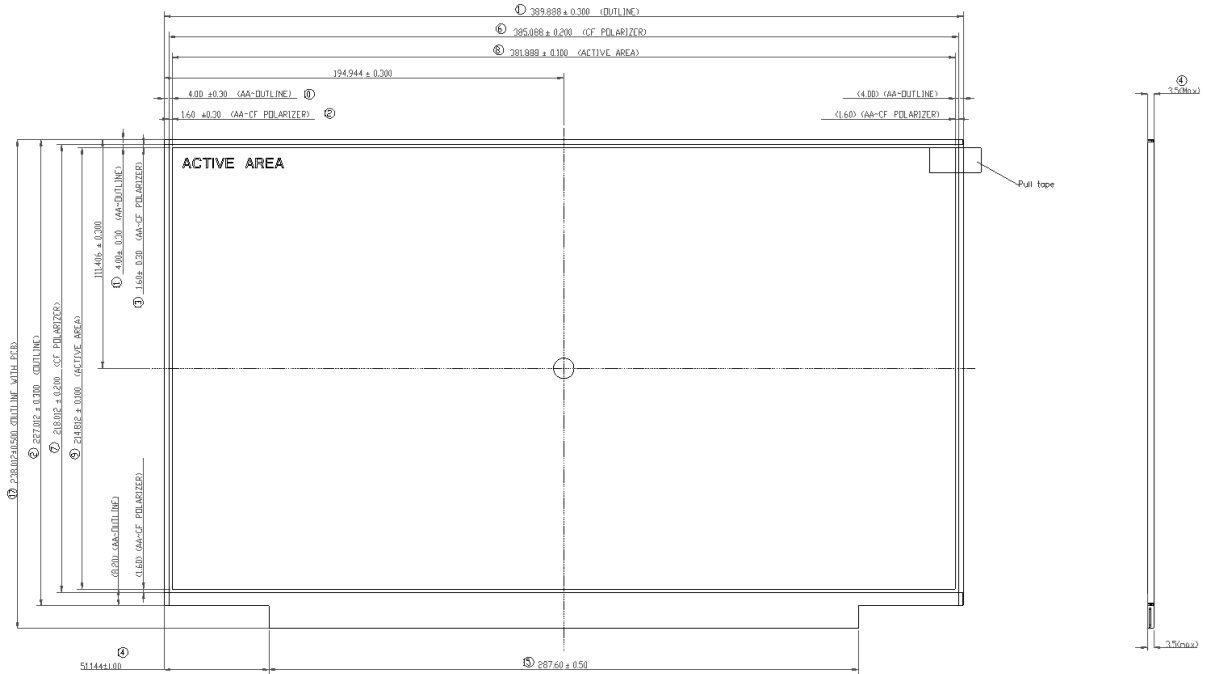

Figure 24. TFT-LCD Module Outline Dimension (Front View)

NOTES:

1. WARPAGE AND DEFORMATION SPEC.: 0.5mm Max.
2. EDP CONNECTOR IS MEASURED AT PIN 1 AND MATING LINE
3. UNSPECIFIED TOLERANCE REFER TO +/- 0.3mm
4. TOP POLARIZER IS THE HIGHEST PORTION.
5. THE MEASUREMENT METHOD FOR THE DIMENSION OF MODULE, PLEASE REFER TO APPENDIX A.
6. CRITICAL DIMENSION: ①-⑱
- CPK: ①-③
7. "()" REFER TO REFERENCE.

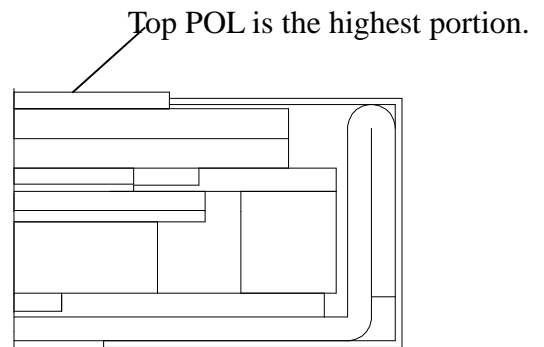

Figure 25. Highest Point Position

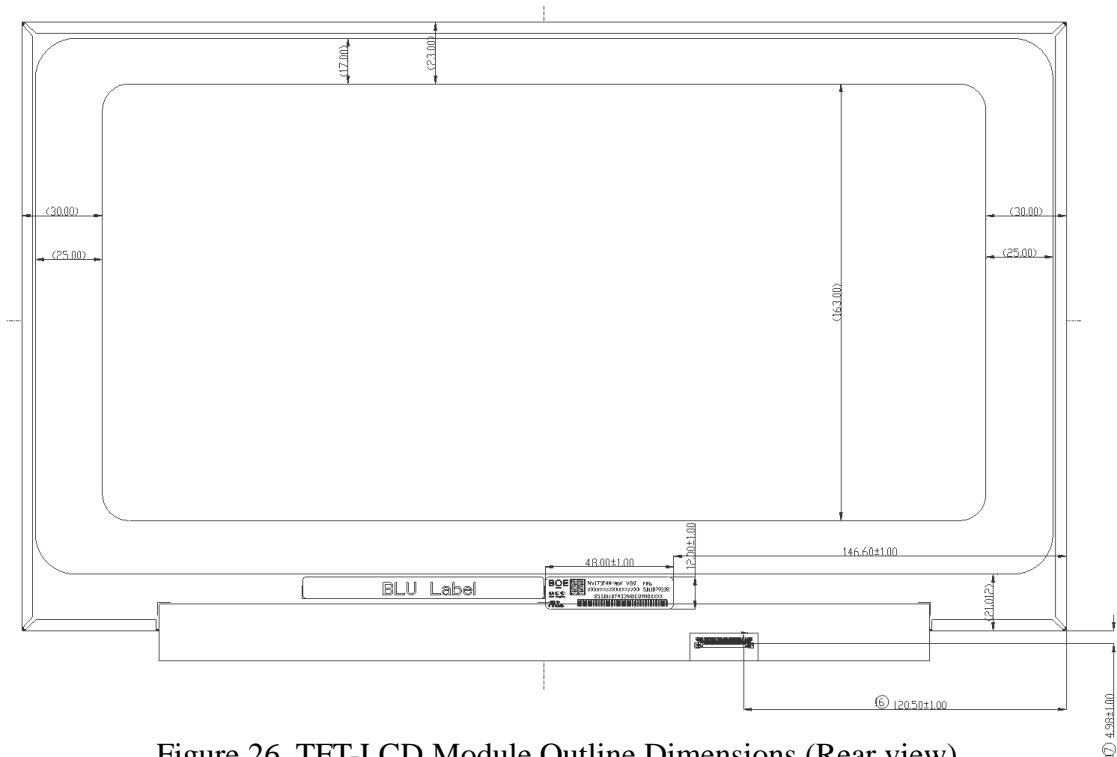

Figure 26. TFT-LCD Module Outline Dimensions (Rear view)

NOTES:

1. WARPAGE AND DEFORMATION SPEC.: 0.5mm Max.
2. EDP CONNECTOR IS MEASURED AT PIN 1 AND MATING LINE
3. UNSPECIFIED TOLERANCE REFER TO +/- 0.3mm
4. TOP POLARIZER IS THE HIGHEST PORTION.
5. THE MEASUREMENT METHOD FOR THE DIMENSION OF MODULE, PLEASE REFER TO APPENDIX A.
6. CRITICAL DIMENSION: ①-⑰
7. "()" REFER TO REFERENCE.

16.0 EDID Table

Check		Address (HEX)	Function	Hex	Dec	crc	Input values.	Notes
FAE	QE							
-	-	00	Header	00	0	-	0	EDID Header
-	-	01		FF	255	-	255	
-	-	02		FF	255	-	255	
-	-	03		FF	255	-	255	
-	-	04		FF	255	-	255	
-	-	05		FF	255	-	255	
-	-	06		FF	255	-	255	
-	-	07		00	0	-	0	
V	-	08	ID Manufacturer Name	09	9	-	BOE	ID = BOE
V	-	09		E5	229	-		
-	V	0A	ID Product Code	34	52	-	3124	ID = 3124
-	V	0B		0C	12	-		
V	-	0C	32-bit serial No.	00	0	-	0	
V	-	0D		00	0	-	0	
V	-	0E		00	0	-	0	
V	-	0F		00	0	-	0	
V	-	10	Week of manufacture	10	16	-	16	
V	-	11	Year of Manufacture	21	33	-	2023	Manufactured in 2023
V	-	12	EDID Structure Ver.	01	1	-	1	EDID Ver 1.0
V	-	13	EDID revision #	04	4	-	4	EDID Rev. 0.4
V	V	14	Video input definition	A5	165	-	-	Refer to right table
-	V	15	Max H image size	26	38	-	38	38.2 cm (Approx)
-	V	16	Max V image size	16	22	-	22	21.5 cm (Approx)
-	V	17	Display Gamma	78	120	-	2.2	Gamma curve = 2.2
V	-	18	Feature support	03	3	-	-	Refer to right table
-	V	19	Red/Green low bits	D3	211	-	-	Red / Green Low Bits
-	V	1A	Blue/White low bits	35	53	-	-	Blue / White Low Bits
-	V	1B	Red x high bits	A3	163	655	0.640	Red (x) = 10100011 (0.64)
-	V	1C	Red y high bits	57	87	349	0.341	Red (y) = 01010111 (0.341)
-	V	1D	Green x high bits	52	82	328	0.320	Green (x) = 01010010 (0.32)
-	V	1E	Green y high bits	9F	159	639	0.624	Green (y) = 10011111 (0.624)
-	V	1F	Blue x high bits	28	40	160	0.156	Blue (x) = 00101000 (0.156)
-	V	20	Blue y high bits	0E	14	59	0.058	Blue (y) = 00001110 (0.058)
-	V	21	White x high bits	50	80	321	0.313	White (x) = 01010000 (0.313)
-	V	22	White y high bits	54	84	337	0.329	White (y) = 01010100 (0.329)
V	-	23	Established timing 1	00	0	-	-	Refer to right table
V	-	24	Established timing 2	00	0	-	-	
V	-	25	Established timing 3	00	0	-	-	

V	-	26	Standard timing #1	01	1	-	-	Not Used
V	-	27		01	1	-	-	
V	-	28	Standard timing #2	01	1	-	-	Not Used
V	-	29		01	1	-	-	
V	-	2A	Standard timing #3	01	1	-	-	Not Used
V	-	2B		01	1	-	-	
V	-	2C	Standard timing #4	01	1	-	-	Not Used
V	-	2D		01	1	-	-	
V	-	2E	Standard timing #5	01	1	-	-	Not Used
V	-	2F		01	1	-	-	
V	-	30	Standard timing #6	01	1	-	-	Not Used
V	-	31		01	1	-	-	
V	-	32	Standard timing #7	01	1	-	-	Not Used
V	-	33		01	1	-	-	
V	-	34	Standard timing #8	01	1	-	-	Not Used
V	-	35		01	1	-	-	
-	V	36	Detailed timing/monitor descriptor #1	3B	59	-	143.9	143.9424MHz Main clock
-	V	37		38	56	-		
-	V	38		80	128	-	1920	Hor Active = 1920
-	V	39		DE	222	-	222	Hor Blanking = 222
-	V	3A		70	112	-	-	4 bits of Hor. Active + 4 bits of Hor. Blanking
-	V	3B		38	56	-	1080	Ver Active = 1080
-	V	3C		28	40	-	40	Ver Blanking = 40
-	V	3D		40	64	-	-	4 bits of Ver. Active + 4 bits of Ver. Blanking
-	V	3E		30	48	-	48	Hor Sync Offset = 48
-	V	3F		20	32	-	32	H Sync Pulse Width = 32
-	V	40		36	54	-	3	V sync Offset = 3 line
-	V	41		00	0	-	6	V Sync Pulse width : 6 line
-	V	42		7E	126	-	382	Horizontal Image Size = 382 mm (Low 8 bits)
-	V	43		D7	215	-	215	Vertical Image Size = 215 mm (Low 8 bits)
-	V	44		10	16	-	-	4 bits of Hor Image Size + 4 bits of Ver Image Size
-	V	45		00	0	-	0	Hor Border (pixels)
-	V	46		00	0	-	0	Vertical Border (Lines)
-	V	47	1A	26	-	-	Refer to right table	

V	-	48	Detailed timing/monitor descriptor #2	00	0	-	-	Indicates descriptor is a display Descriptor
V	-	49		00	0	-	-	
V	-	4A		00	0	-	-	Reserved
V	-	4B		FD	253	-	-	Tag Number for Display Range Limits Descriptor
V	-	4C		00	0	-	-	Vertical/Horizontal Rate Offset are zero
V	-	4D		28	40	-	40	Minimum Vertical Rate:40 Hz
V	-	4E		3C	60	-	60	Maximum Vertical Rate:60 Hz
V	-	4F		43	67	-	67.2	Minimum Horizontal Rate:67.2 kHz
V	-	50		43	67	-	67.2	Maximum Horizontal Rate:67.2 kHz
V	-	51		0E	14	-	143.9424	Maximum Pixel Clock:143.9424 MHz
V	-	52		01	1	-	-	Range Limits Only
V	-	53		0A	10	-	-	Display Range Limits & CVT Support Definition
V	-	54		20	32	-	-	
V	-	55		20	32	-	-	
V	-	56		20	32	-	-	
V	-	57		20	32	-	-	
V	-	58		20	32	-	-	
V	-	59		20	32	-	-	
V	-	5A		Detailed timing/monitor descriptor #3	00	0	-	-
V	-	5B	00		0	-	-	
V	-	5C	00		0	-	-	Reserved
V	-	5D	FE		254	-	-	Tag: ASCII String
V	-	5E	00		0	-	-	Reserved
V	-	5F	42		66	-	B	Manufacture name : BOE-CQ
V	-	60	4F		79	-	O	
V	-	61	45		69	-	E	
V	-	62	20		32	-	-	
V	-	63	43		67	-	C	
V	-	64	51		81	-	Q	
V	-	65	0A		10	-	-	
V	-	66	20		32	-	-	
V	-	67	20		32	-	-	
V	-	68	20	32	-	-		
V	-	69	20	32	-	-		
V	-	6A	20	32	-	-		
V	-	6B	20	32	-	-		

V	-	6C	Detailed timing/monitor descriptor #4	00	0	-	-	Indicates descriptor #4 is a display Descriptor	
V	-	6D		00	0	-	-		
V	-	6E		00	0	-	-	Reserved	
V	-	6F		FE	254	-	-	Tag: ASCII String	
V	-	70		00	0	-	-	Reserved	
V	-	71		4E	78	-	N	Model name : NV173FHM-N6K	
V	-	72		56	86	-	V		
V	-	73		31	49	-	1		
V	-	74		37	55	-	7		
V	-	75		33	51	-	3		
V	-	76		46	70	-	F		
V	-	77		48	72	-	H		
V	-	78		4D	77	-	M		
V	-	79		2D	45	-	-		
V	-	7A		4E	78	-	N		
V	-	7B		36	54	-	6		
V	-	7C		4B	75	-	K		
V	-	7D		0A	10	-	-		
V	V	7E		Extension flag	00	0	-	1	0 : 1個EDID; N-1: N個EDID
-	-	7F		Checksum	53	83	83	-	

17.0 GENERAL PRECAUTIONS

17.1 HANDLING

(1) When the module is assembled, It should be attached to the system firmly using every mounting holes.

Be careful not to twist or bend the modules.

(2) Refrain from strong mechanical shock or any force to the module. Otherwise, it may cause improper operation or damage to the module.

(3) Note that polarizers are very fragile and could be easily damaged. Do not press or scratch the surface harder than 1 HB pencil lead.

(4) Wipe off water droplets or oil immediately. If you leave the droplets for a long time, Staining and discoloration may occur.

(5) If the surface of the polarizer is dirty, clean it using some absorbent cotton or soft cloth.

(6) The desirable cleaners are water, IPA (Isopropyl Alcohol) or Hexane. Do not use Ketone type materials(ex. Acetone), Ethyl alcohol, Toluene, Ethyl acid or Methyl chloride. It might permanently damage to the polarizer due to chemical reaction.

(7) If the liquid crystal material leaks from the panel, it should be kept away from the eyes or mouth .In case of contact with hands, legs or clothes, it must be washed away thoroughly with soap.

(8) Protect the module from static , it may cause damage to the module.

(9) Use fingerstalls with soft gloves to keep display clean during the incoming inspection and assembly process.

(10) Do not disassemble the module.

(11) Do not pull or fold the LED FPC.

(12) Do not touch any component which is located on the back side.

(13) Protection film for polarizer on the module shall be slowly peeled off just before use so that the electrostatic charge can be minimized.

(14) Pins of connector shall not be touched directly with bare hands.

17.2 STORAGE

(1) Do not leave the module in high temperature, and high humidity for a long time. It is highly recommended to store the module with temperature from 0 to 35°C and relative humidity of less than 70%.

(2) Do not store the TFT-LCD module in direct sunlight.

(3) The module shall be stored in a dark place. It is prohibited to apply sunlight or fluorescent light during the store.

17.3 OPERATION

- (1) Do not connect, disconnect the module in the “ Power On” condition.
- (2) Power supply should always be turned on/off by following item 8.0 “ Power on/off sequence “.
- (3) Module has high frequency circuits. Sufficient suppression to the electromagnetic interference shall be done by system manufacturers. Grounding and shielding methods may be important to minimize the interference.
- (4) The standard limited warranty is only applicable when the module is used for general notebook applications. If used for purposes other than as specified, BOE is not to be held reliable for the defective operations. It is strongly recommended to contact BOE to find out fitness for a particular purpose.

17.4 OTHERS

- (1) Avoid condensation of water. It may result in improper operation or disconnection of electrode.
- (2) Do not exceed the absolute maximum rating value. (the supply voltage variation, input voltage variation, Variation in part contents and environmental temperature, so on) Otherwise the module may be damaged.
- (3) If the module displays the same pattern continuously for a long period of time, it can be the situation when The “ image sticks” to the screen.
- (4) This module has its circuitry PCB’s on the rear or bottom side and should be handled carefully to avoid being stressed.

Appendix A

The Measurement Methods for the Dimensions of Module

Caliper:

- a. Length of Outline
- b. Width of Outline (Without/With PCB)
- c. Thickness of Outline (Without/ With PCB)

Coordinate Measuring Machine:

CF Polarizer Size

Active Area Size

Active Area to Outline (Without Tape Wrinkle or Bulged)

Active Area to CF Polarizer

The Distance of Bracket Holes

P-Cover to Outline (Without Tape Wrinkle or Bulged)

Length of P-Cover

Connector Pin 1 to Outline (Without Tape Wrinkle or Bulged)

Height Gauge: The Different Height of Root and Top on the Bracket
(Need to Calculate From Bracket Angle Spec.)

Feeler Gauge: The Warpage Spec. of Module

Notes:

Except the Critical Dimensions as Above, Other Dimensions are Measured by Coordinate Measuring Machine If Necessary.

Appendix B

LCM to A-Cover / sponges z-gap

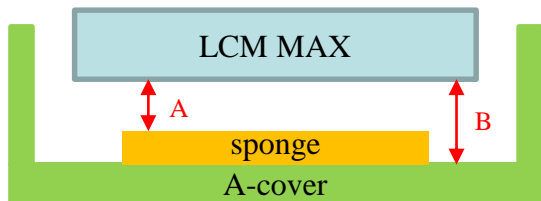
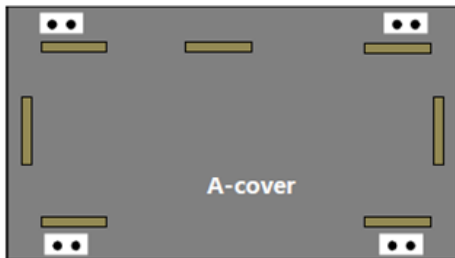
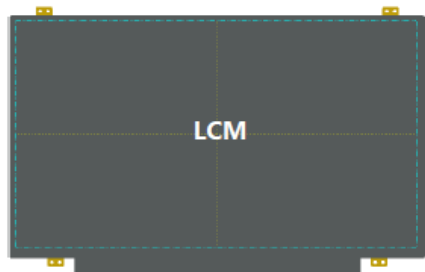

	Plastic Cover (LCM Thickness: Max)	Metal Cover (LCM Thickness: Max)
A	>0mm	>0mm
B	Min: 1.0mm	Min: 0.8mm
Without the open area of back cover		

Purpose

The reflector area is very sensitive, we suggest that design enough z-gap to decrease the risk of water ripple, white spot and other abnormal display

Appendix B

LCM to A-Cover / sponges z-gap

a

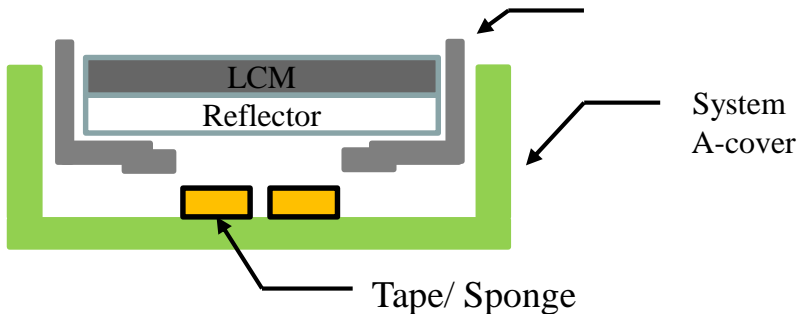

b

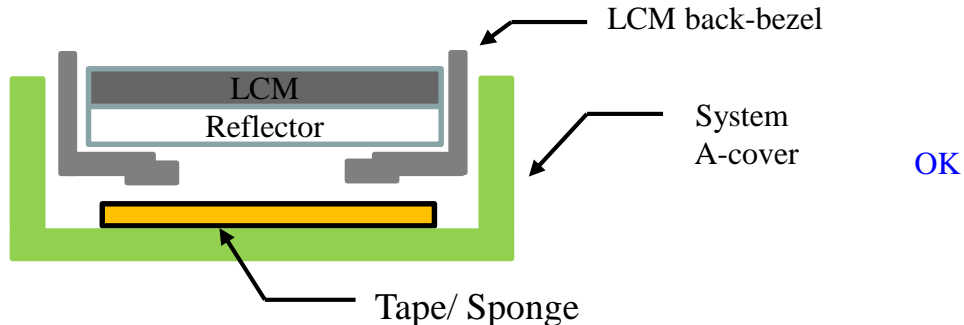

Purpose

If attach sponges or rubbers which correspond to white reflector area, it may cause white spot, pooling or other relate issues. We suggest that attach wide range sponges / rubbers which can cover the LCM back-bezel opening

Appendix B

LCM to side wall / protrusions

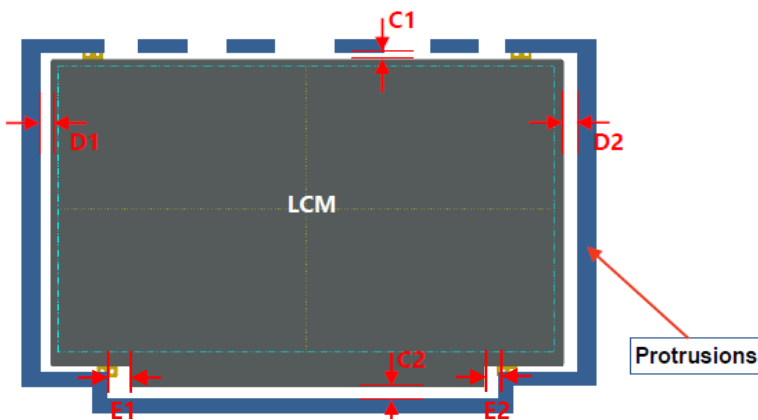

	Normal border	Narrow border
D1/D2	Min: 0.45mm	Min: 0.35mm
C1	Min: 0.50mm	
C2	Min: 0.50mm	
E1/E2	Min: 0.55mm	

Purpose

We suggest that design enough gap around LCM to prevent shock test failure, or interference, cell crack, abnormal display...etc. in the reliability test

Appendix B

LCM to B-cover z-gap



B-cover Tape	Gap
Without	0.15 ~ 0.25mm
With	0.15 ~ 0.20mm

Purpose

Too less z-gap between system B-cover and LCM top pol has high risk to cause cell crack, pooling, light leakage and other issues

Appendix B

B-cover tape to top pol edge

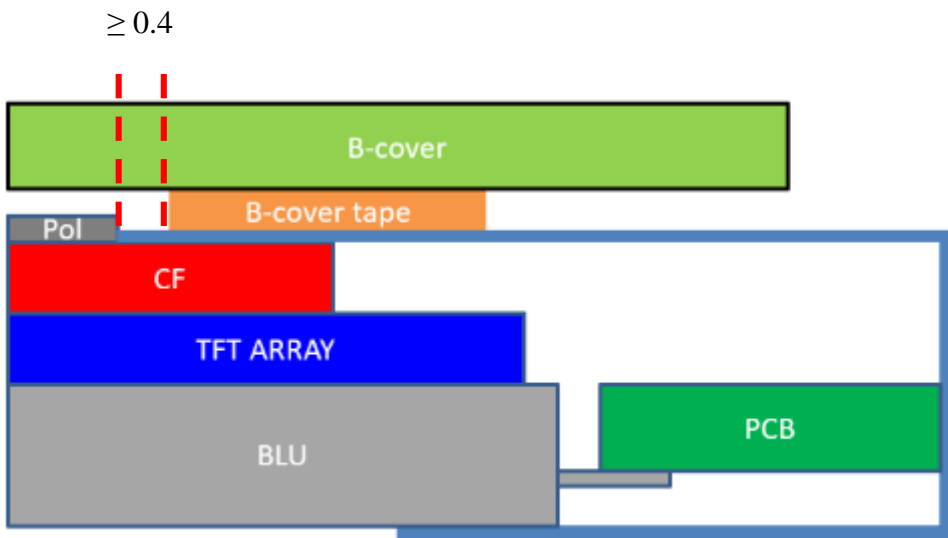

If attach b-cover and LCM with tapes,
Please let tapes to be located out of top pol edges 0.4mm away on 4 sides

Purpose

To avoid the B-cover tape override top pol and cause pooling or light leakage issue

Appendix B

Antenna Cable & Webcam wire

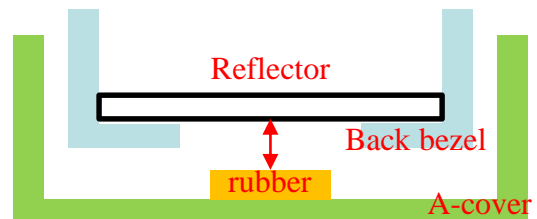
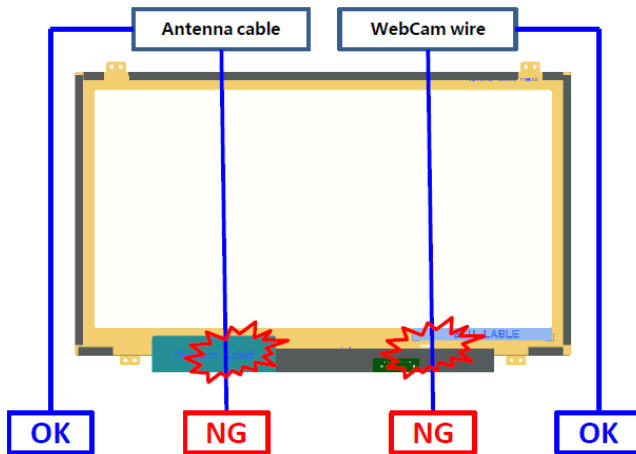

If sponge within the reflector area is necessary, we suggest that the gap between reflector and sponge is more than 0.5mm

Purpose

1. We suggest that do not set Antenna or WebCam cable / wire go behind LCM to avoid backpack test, hinge test ,twist test or pogo test with abnormal display
2. If the cable / wire is necessary to go behind LCM, please make a groove with rounds or chamfers to protect the cable / wire, or attach with higher sponge / rubbers adjacent to the cable / wire route
3. Suggest that attach the cable / wire with tapes to A-cover
4. Do not attach anything with LCM reflector area. If attach cable / wire with LCM reflector area, it may cause pooling, white spot, light leakage and other related issues

Appendix B

LCM paste area

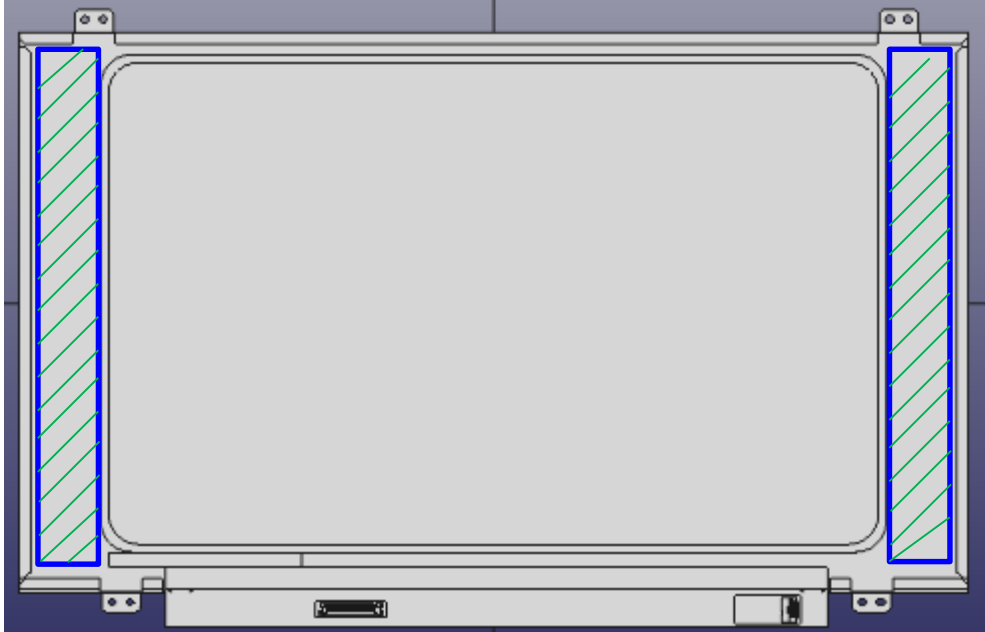

Attachment area

Purpose

If use the stretch remove tapes to fix LCM with A-cover, please set the stretch remove tapes correspond to the LCM back-bezel and do not let the tapes override the back-bezel's level step of opening

Appendix B

LCM pressable area

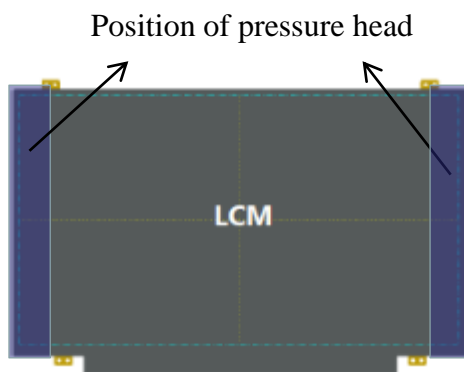
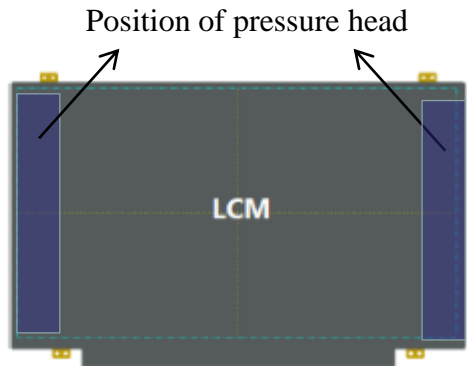

Purpose

1. LCM is fixed on A-cover by double-sided tap which can stick LCM after using the press jig stress LCM during assembling.
2. To avoid panel broken the design of pressure head of press jig can not only pin on cell panel. The pressure head needs to pin on the LCM frame, which the LCM frame can share the pressure of the pressing head.

Appendix B

Wire setting

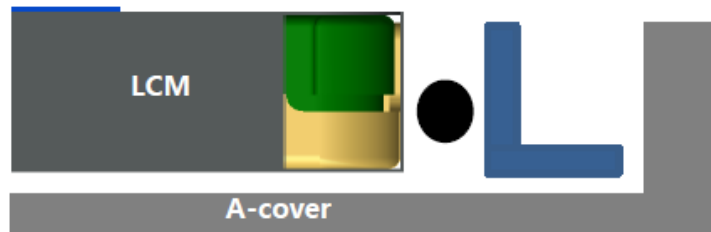
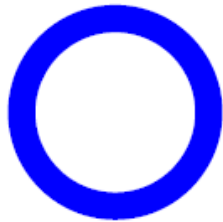

Purpose

Wire should be placed between Protrusions and A-cover. If place the wire between LCM and Protrusions, it may interfere with LCM when assembling B-covers, or even cause LCM breakage in reliability test.

Appendix B

A-cover strength

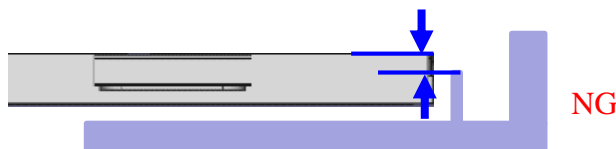
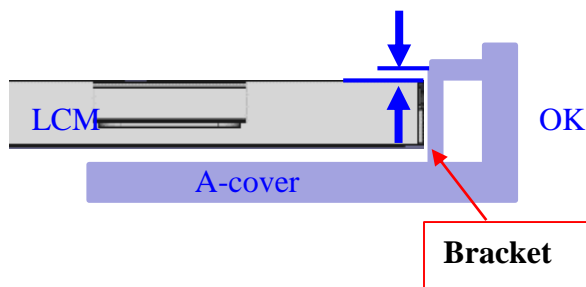
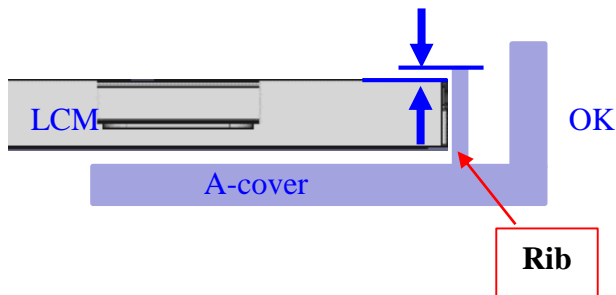

Purpose

1. It is recommended that Rib height is higher than LCM, in order to avoiding press on LCM edge panels.
2. As for LCM is more stronger than Rib, the L Bracket is be recommended.

Appendix B

System A-cover Inner Surface

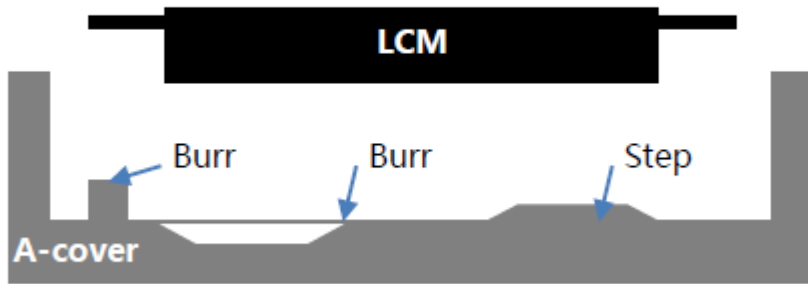

Purpose

There should not exist any burr, segment gap or protrusions beside Logo, which would cause White Spot or Glass Broken by stress concentration.

Appendix B

Keyboard area & Mouse pad

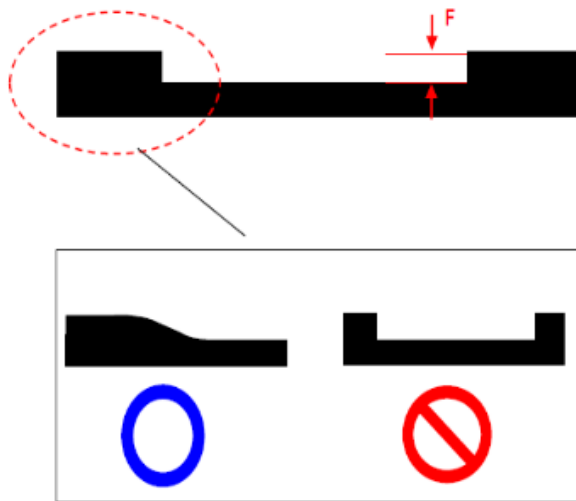
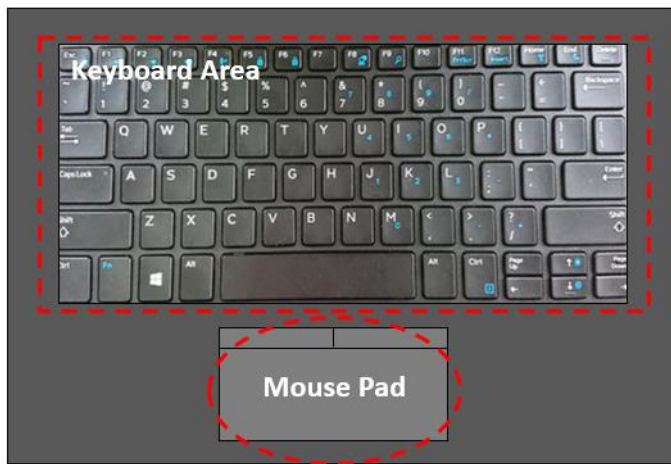

➤ F: max 0.3mm

Purpose

In order to avoiding LCM fragments in reliability test, the step surface of Keyboard and Mouse pad transmits smoothly, and should not be right-angle. For example, when Pogo testing, if the broken hole is done in this location, it is easy to produce fragments.

Appendix B

System cover reliability

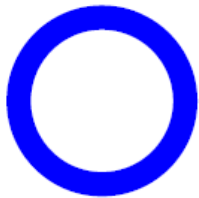

Purpose

The permanent deformation part of System cover after the reliability test, including sponge and other structures or components, can not touch LCM.

Appendix B

A/B-cover near LCD PCBA

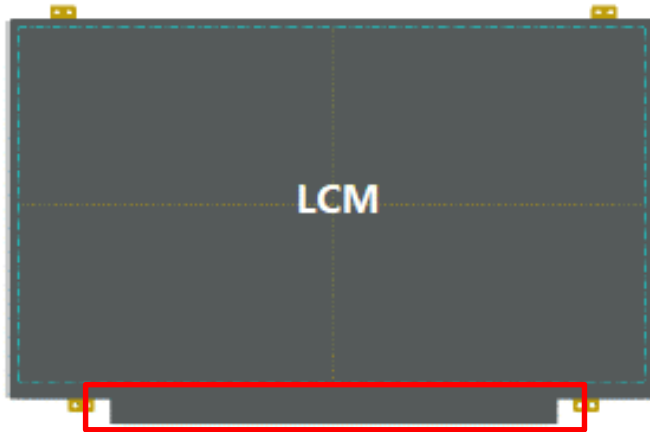

No magnetic object

Purpose

There should not have magnet object near LCM PCBA, which is prone to cause physical or electricity noise issue

Appendix B

A-cover add sponges on Boss side wall

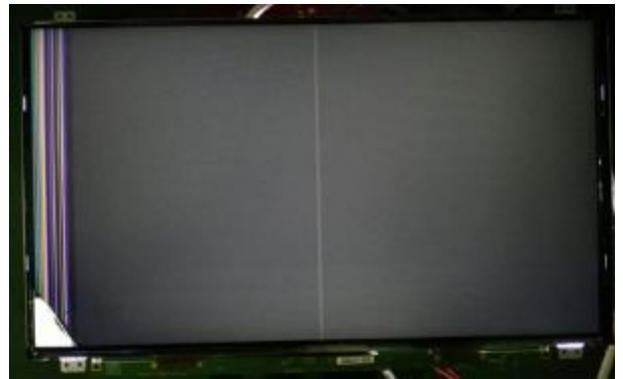
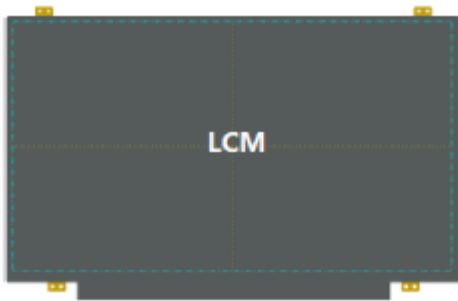
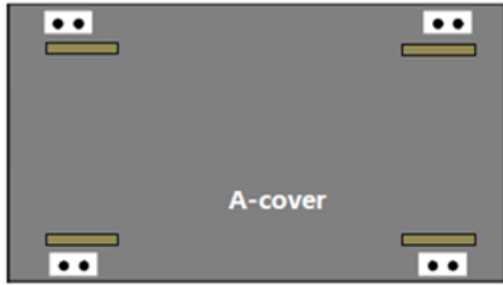

Purpose

We suggest to attach Sponges to the side of the Boss column of A-cover to reduce the panel broken possibility in assembly. It is recommended to this design synchronously.

Appendix B

LCM to A-Cover / sponges z-gap

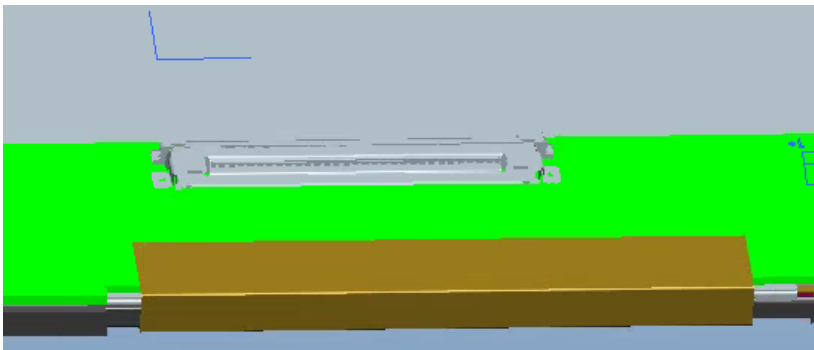
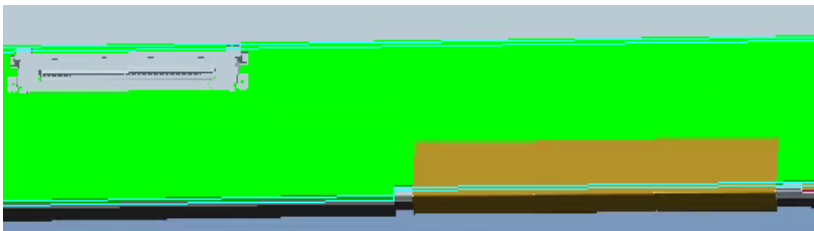

Purpose

Bent product: The position of system connector and FPC should be staggered in X direction. Otherwise, when testing, the system Cable line extrudes FPC, leading to FPC Crack; (Panel FPC Bonding location is related to Mask and can not be changed easily)

Appendix C

HPD Signal recognition

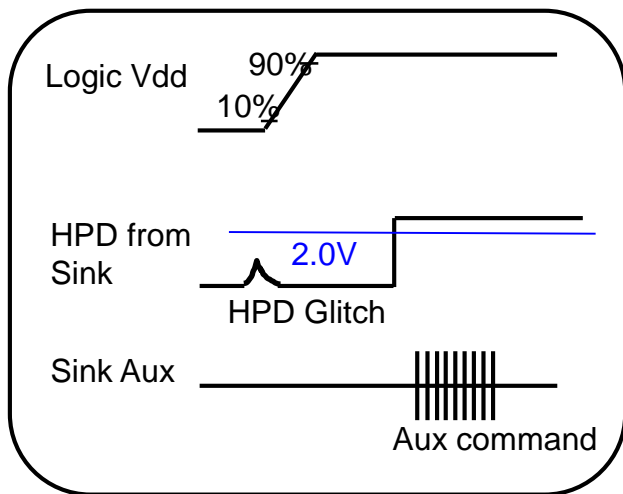

Normal Signal (Ignore HPD Glitch)

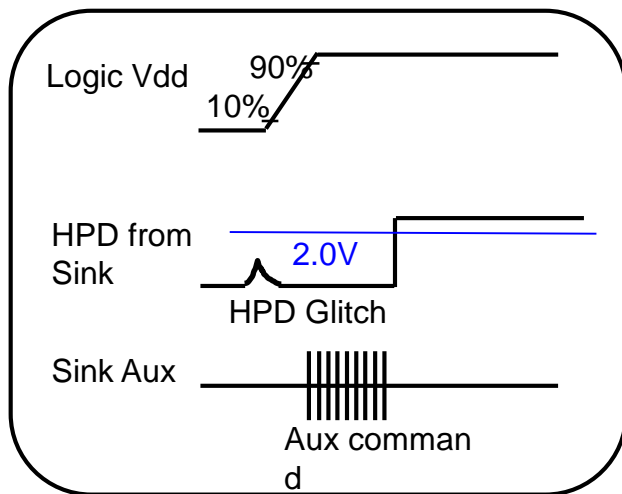

Abnormal Signal

Purpose

When HPD glitch voltage less than 2.0(V), system signal can't output AUX command data.

Appendix C

HPD Signal Definition IRQ (Interrupt Request)

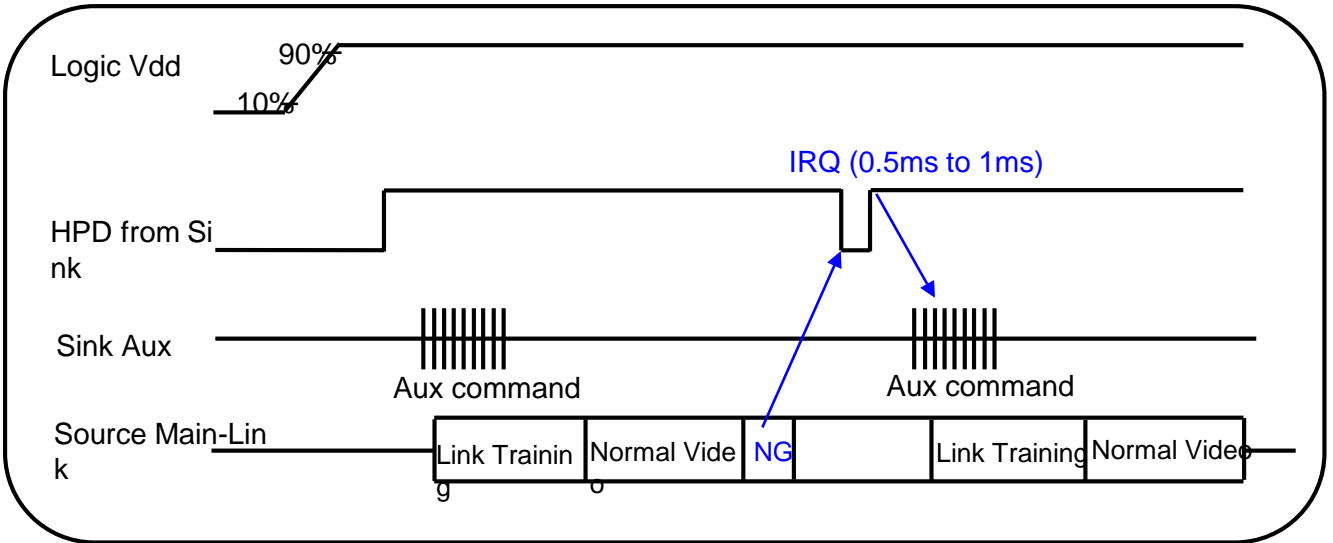

Purpose

When HPD signal low than 0.5ms to 1ms, the source device should check sink status field from the DPCD and take link training again.

Appendix C

Main link eye diagram of TP3

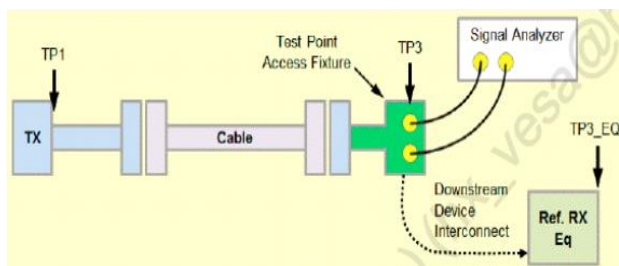

Measured TP3 on LCM connector.

	UI	Voltage
1	0.246	0
2	0.5	0.075
3	0.755	0
4	0.5	-0.075

Eye for TP3 at HBR

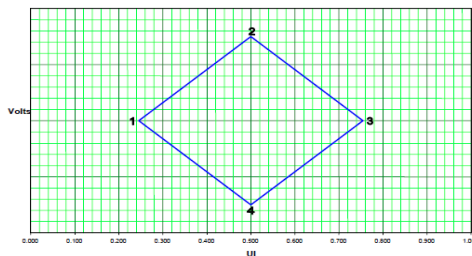

Downstream Device Mask at TP3

	UI	Voltage
1	0.375	0
2	0.5	0.023
3	0.625	0
4	0.5	-0.023

Eye for TP3 at RBR

Purpose

1. Main Link EYE Diagram should meet TP3 point of VESA.
2. The measure method is through access fixture.

Appendix C

Impedance Profile through a DP Connector

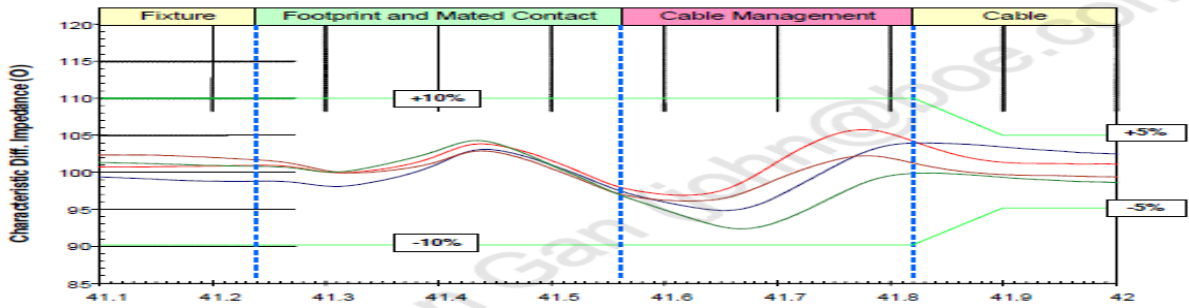

Differential Impedance Profile Measurement Data Example

Segment	Differential Impedance Value	Maximum Tolerance
Fixture	100Ω/VESA	±10%
Connector	100Ω/VESA	±10%
Wire management	100Ω/VESA	±10%
Cable	100Ω/VESA	±5%

Impedance Profile Values for Cable Assembly

Purpose

Cable Impedance Profile 100ohm for Cable Assembly

Appendix C

Main Link Pixel Freq information value of MSA data

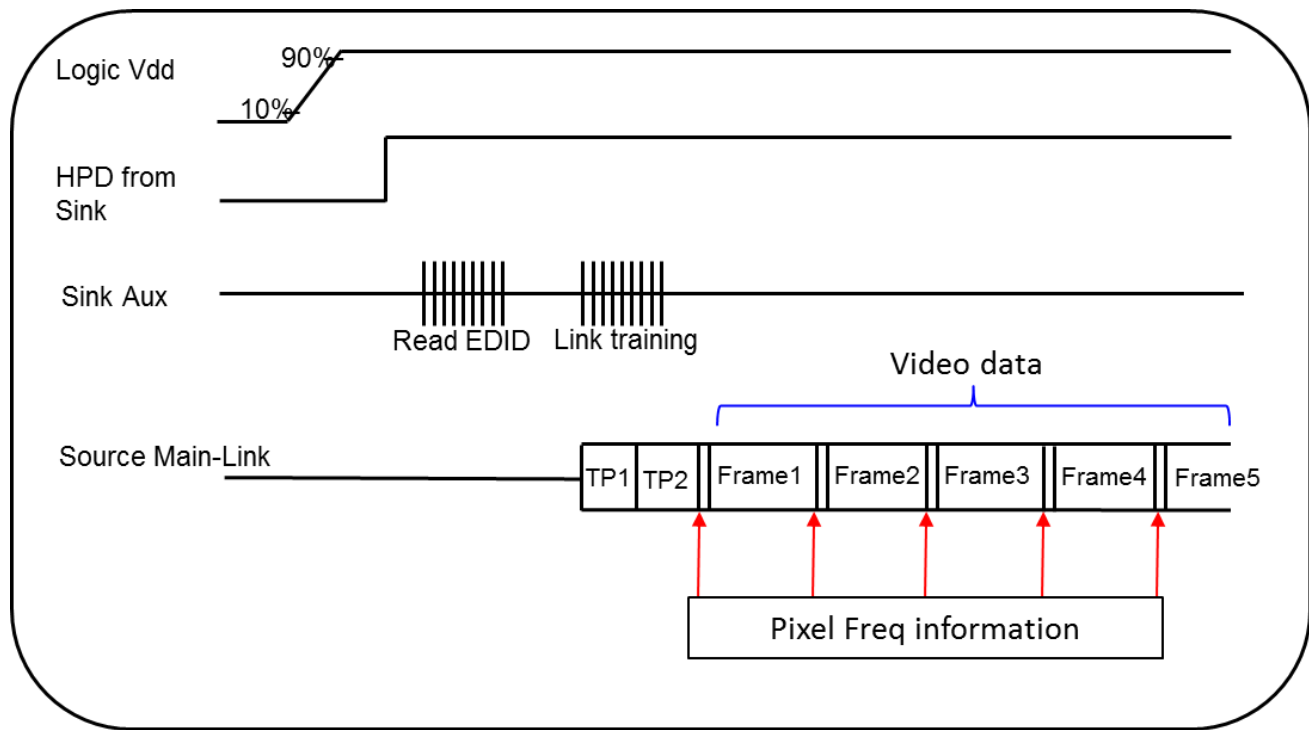

Purpose

1. It need to fix pixel freq information value of MSA data output to prevent the initial abnormal pixel freq information value from incoming after power on.
2. BOE can read DPCD to check this value. Ex: BIOS is 1.62G , but into windows is 2.7G.

Appendix C

Main Link Pixel Freq information value of MSA data

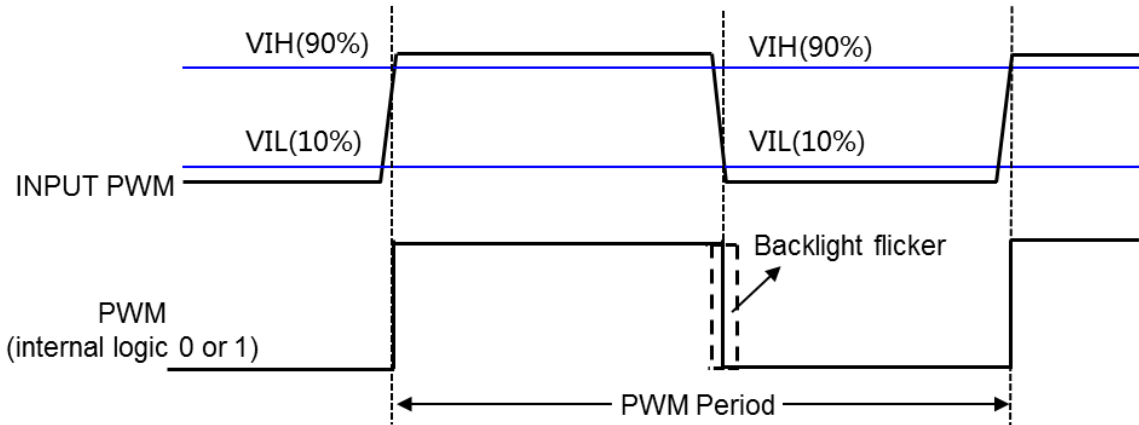

Example:

Freq	Cycle Time	PWM Rising Time	PWM Falling Time
200Hz	5ms	$\leq 1\mu s$	$\leq 1\mu s$
1KHz	1ms	$\leq 200ns$	$\leq 200ns$

Purpose

1. LED driver need to calculate the duty cycle of input PWM signal.
2. To avoid backlight flicker visible on LCD, system input PWM suggest :
PWM rising $\leq 200ppm \cdot \text{cycle time}$; PWM falling $\leq 200ppm \cdot \text{cycle time}$.