



Product Specification

M170ETN01.1

AU OPTRONICS CORPORATION

- () Preliminary Specification
(V) Final Specification

Module	17" Color TFT-LCD
Model Name	M170ETN01.1 (ES7.0 from 10B)

<table> <tr> <td style="width: 50%; text-align: center;">Customer</td> <td style="width: 50%; text-align: center;">Date</td> </tr> <tr> <td style="text-align: center;">_____</td> <td style="text-align: center;">_____</td> </tr> <tr> <td style="text-align: center;">Approved by</td> <td></td> </tr> <tr> <td style="text-align: center;">_____</td> <td></td> </tr> </table>	Customer	Date	_____	_____	Approved by		_____		<table> <tr> <td style="width: 50%; text-align: center;">Approved by</td> <td style="width: 50%; text-align: center;">Date</td> </tr> <tr> <td style="text-align: center;"><u>Howard Lee</u></td> <td style="text-align: center;"><u>Jan 1, 2016</u></td> </tr> <tr> <td style="text-align: center;">Prepared by</td> <td style="text-align: center;">Date</td> </tr> <tr> <td style="text-align: center;"><u>Jia Hau Jean</u></td> <td style="text-align: center;"><u>Jan 1, 2016</u></td> </tr> </table>	Approved by	Date	<u>Howard Lee</u>	<u>Jan 1, 2016</u>	Prepared by	Date	<u>Jia Hau Jean</u>	<u>Jan 1, 2016</u>
Customer	Date																
_____	_____																
Approved by																	

Approved by	Date																
<u>Howard Lee</u>	<u>Jan 1, 2016</u>																
Prepared by	Date																
<u>Jia Hau Jean</u>	<u>Jan 1, 2016</u>																
<p>Note: This Specification is subject to change without notice.</p>	<p>AU Optronics corporation</p>																



Product Specification

M170ETN01.1

AU OPTRONICS CORPORATION

Contents

1 Handling Precautions	4
2 General Description	5
2.1 Display Characteristics	5
2.2 Absolute Maximum Rating of Environment	6
2.3 Optical Characteristics	7
2.4 Mechanical Characteristics.....	11
3 TFT-LCD Module	12
3.1 Block Diagram.....	12
3.2 Interface Connection	13
3.2.1 Connector Type.....	13
3.2.2 Connector Pin Assignment	13
3.3 Electrical Characteristics	15
3.3.1 Absolute Maximum Rating.....	15
3.3.2 Recommended Operating Condition	15
3.4 Signal Characteristics.....	16
3.4.1 LCD Pixel Format.....	16
3.4.2 LVDS Data Format	16
3.4.3 Color versus Input Data.....	17
3.4.4 LVDS Specification	18
3.4.5 Input Timing Specification.....	20
3.4.6 Input Timing Diagram	21
3.5 Power ON/OFF Sequence.....	22
4 Backlight Unit	23
4.1 Block Diagram.....	23
4.2 Interface Connection	24
4.2.1 Connector Type.....	24
4.2.2 Connector Pin Assignment	26
4.3.1 Absolute Maximum Rating.....	27
4.3.2 Recommended Operating Condition	27
5 Reliability Test	29
6 Shipping Label	30
7 Mechanical Characteristics	31
8 Packing Specification	32
8.1 Packing Flow.....	32
8.2 Pallet and shipment information	33





Product Specification

M170ETN01.1

AU OPTRONICS CORPORATION

Record of Revision

Version	Date	Page	Old description	New Description	Remark																																																																																																									
0.0	2013/2/6	All	First version release	-																																																																																																										
0.1	2013/4/8	7	Color Coordinates is TBD	Update Color Coordinates																																																																																																										
1.0	2013/6/11	13	Three connector type	Two connector type																																																																																																										
		20		Min.	Typ.	Max.		Min.	Typ.	Max.																																																																																																				
			Horizontal section Frequency(KHz)	37.8	54	68.4	Horizontal section Frequency(KHz)	51.8	64	93.7																																																																																																				
			LVDS clock period (ns)	50	60	76	LVDS clock period (ns)	14.6	18.5	26																																																																																																				
			LVDS clock Frequency(MHz)	51.8	64	93.7	LVDS clock Frequency(MHz)	37.8	54	68.4																																																																																																				
27, 28	NA	Add Note 4-5 Recommendation for LED driver power design																																																																																																												
28	$P_{BLU} (Max.) = V_s (Max.) \times I_s (Max.) \times 4$	$P_{BLU} (Max.) = V_s (Max.) \times I_s (Typ.) \times 4$																																																																																																												
1.1	2014/3/10	14,26,31			Modify Mylar																																																																																																									
2.0	2016/1/1	All	Product specification release		ES7.0																																																																																																									
2.1	2016/1/1	5	9.9 (Typ.) LCD module : PDD (Typ.)=3 @ Black pattern,Fv=60Hz Backlight unit : P _{BLU} (Typ.)=8.9 @Is=60mA	8.4W (Typ.) LCD module : PDD (Typ.)=3W @ Black pattern,Fv=60Hz Backlight unit : P _{BLU} (Typ.)=5.4W @Is=50mA																																																																																																										
		7	Test Condition: 1. Equipment setup: Please refer to Note 2-2 . 2. Panel Lighting time: 30 minutes 3. VDD=5.0V, Fv=60Hz,Is=60mA,Ta=25°C	Test Condition: ⁴ 1. Equipment setup: Please refer to Note 2-2 . 2. Panel Lighting time: 30 minutes ⁴ 3. VDD=5.0V, Fv=60Hz,Is=50mA,Ta=25°C																																																																																																										
		27	<table border="1"> <thead> <tr> <th>Symbol</th> <th>Description</th> <th>Min.</th> <th>Typ.</th> <th>Max.</th> <th>Unit</th> <th>Remark</th> </tr> </thead> <tbody> <tr> <td>Is</td> <td>LED String Current</td> <td>-</td> <td>63</td> <td>95</td> <td>[mA]</td> <td>100% duty ratio of LED chip</td> </tr> <tr> <td>Vs</td> <td>LED String Voltage</td> <td>25.2</td> <td>29.8</td> <td>32.4</td> <td>[VOLT]</td> <td>Is=5mA@100% duty ratio; Note 4-1 Note 4-2</td> </tr> <tr> <td>VH</td> <td>Light Bar Open on Voltage (for reference)</td> <td>75.7</td> <td>76.8</td> <td>80.4</td> <td>[VOLT]</td> <td>Is=5mA@100% duty ratio; Note 4-1 Note 4-2</td> </tr> <tr> <td>VDS</td> <td>Maximum Vs Voltage (1/3 screen of light bar)</td> <td>-</td> <td>-</td> <td>1.8</td> <td>[VOLT]</td> <td>Is=5mA@100% duty ratio; Note 4-2</td> </tr> <tr> <td>PBLU</td> <td>LED Light Bar Power Consumption</td> <td>-</td> <td>5.9</td> <td>6.3</td> <td>[Watt]</td> <td>Note 4-3</td> </tr> <tr> <td>LT₅₀</td> <td>LED Life Time</td> <td>50,000</td> <td>-</td> <td>-</td> <td>[Hour]</td> <td>Note 4-4</td> </tr> <tr> <td>OVP</td> <td>Over Voltage Protection (in system board)</td> <td>110% V_{d(Max.)}</td> <td>-</td> <td>-</td> <td>[VOLT]</td> <td>Note 4-5</td> </tr> </tbody> </table>	Symbol	Description	Min.	Typ.	Max.	Unit	Remark	Is	LED String Current	-	63	95	[mA]	100% duty ratio of LED chip	Vs	LED String Voltage	25.2	29.8	32.4	[VOLT]	Is=5mA@100% duty ratio; Note 4-1 Note 4-2	VH	Light Bar Open on Voltage (for reference)	75.7	76.8	80.4	[VOLT]	Is=5mA@100% duty ratio; Note 4-1 Note 4-2	VDS	Maximum Vs Voltage (1/3 screen of light bar)	-	-	1.8	[VOLT]	Is=5mA@100% duty ratio; Note 4-2	PBLU	LED Light Bar Power Consumption	-	5.9	6.3	[Watt]	Note 4-3	LT ₅₀	LED Life Time	50,000	-	-	[Hour]	Note 4-4	OVP	Over Voltage Protection (in system board)	110% V _{d(Max.)}	-	-	[VOLT]	Note 4-5	<table border="1"> <thead> <tr> <th>Symbol</th> <th>Description</th> <th>Min.</th> <th>Typ.</th> <th>Max.</th> <th>Unit</th> <th>Remark</th> </tr> </thead> <tbody> <tr> <td>Is</td> <td>LED String Current</td> <td>-</td> <td>50</td> <td>95</td> <td>[mA]</td> <td>100% duty ratio of LED chip</td> </tr> <tr> <td>Vs</td> <td>LED String Voltage</td> <td>25.2</td> <td>27.6</td> <td>28.2</td> <td>[VOLT]</td> <td>Is=5mA@100% duty ratio; Note 4-1 Note 4-2</td> </tr> <tr> <td>VDS</td> <td>Maximum Vs Voltage (Definition of light bar)</td> <td>-</td> <td>-</td> <td>1.8</td> <td>[VOLT]</td> <td>Is=5mA@100% duty ratio; Note 4-2</td> </tr> <tr> <td>PBLU</td> <td>LED Light Bar Power Consumption</td> <td>-</td> <td>5.9</td> <td>6.3</td> <td>[Watt]</td> <td>Note 4-3</td> </tr> <tr> <td>LT₅₀</td> <td>LED Life Time</td> <td>30,000</td> <td>-</td> <td>-</td> <td>[Hour]</td> <td>Note 4-4</td> </tr> <tr> <td>OVP</td> <td>Over Voltage Protection (in system board)</td> <td>110% V_{d(Max.)}</td> <td>-</td> <td>-</td> <td>[VOLT]</td> <td>Note 4-5</td> </tr> </tbody> </table>	Symbol	Description	Min.	Typ.	Max.	Unit	Remark	Is	LED String Current	-	50	95	[mA]	100% duty ratio of LED chip	Vs	LED String Voltage	25.2	27.6	28.2	[VOLT]	Is=5mA@100% duty ratio; Note 4-1 Note 4-2	VDS	Maximum Vs Voltage (Definition of light bar)	-	-	1.8	[VOLT]	Is=5mA@100% duty ratio; Note 4-2	PBLU	LED Light Bar Power Consumption	-	5.9	6.3	[Watt]	Note 4-3	LT ₅₀	LED Life Time	30,000	-	-	[Hour]	Note 4-4	OVP	Over Voltage Protection (in system board)	110% V _{d(Max.)}	-	-	[VOLT]	Note 4-5	
			Symbol	Description	Min.	Typ.	Max.	Unit	Remark																																																																																																					
			Is	LED String Current	-	63	95	[mA]	100% duty ratio of LED chip																																																																																																					
Vs	LED String Voltage		25.2	29.8	32.4	[VOLT]	Is=5mA@100% duty ratio; Note 4-1 Note 4-2																																																																																																							
VH	Light Bar Open on Voltage (for reference)		75.7	76.8	80.4	[VOLT]	Is=5mA@100% duty ratio; Note 4-1 Note 4-2																																																																																																							
VDS	Maximum Vs Voltage (1/3 screen of light bar)	-	-	1.8	[VOLT]	Is=5mA@100% duty ratio; Note 4-2																																																																																																								
PBLU	LED Light Bar Power Consumption	-	5.9	6.3	[Watt]	Note 4-3																																																																																																								
LT ₅₀	LED Life Time	50,000	-	-	[Hour]	Note 4-4																																																																																																								
OVP	Over Voltage Protection (in system board)	110% V _{d(Max.)}	-	-	[VOLT]	Note 4-5																																																																																																								
Symbol	Description	Min.	Typ.	Max.	Unit	Remark																																																																																																								
Is	LED String Current	-	50	95	[mA]	100% duty ratio of LED chip																																																																																																								
Vs	LED String Voltage	25.2	27.6	28.2	[VOLT]	Is=5mA@100% duty ratio; Note 4-1 Note 4-2																																																																																																								
VDS	Maximum Vs Voltage (Definition of light bar)	-	-	1.8	[VOLT]	Is=5mA@100% duty ratio; Note 4-2																																																																																																								
PBLU	LED Light Bar Power Consumption	-	5.9	6.3	[Watt]	Note 4-3																																																																																																								
LT ₅₀	LED Life Time	30,000	-	-	[Hour]	Note 4-4																																																																																																								
OVP	Over Voltage Protection (in system board)	110% V _{d(Max.)}	-	-	[VOLT]	Note 4-5																																																																																																								
28	Note 4-4: Definition of life time a. Brightness of LED becomes to 50% of its original value b. Test condition: Is = 60mA and 25°C (Room Temperature)	Note 4-4: Definition of life time. a. Brightness of LED becomes to 50% of its original value b. Test condition: Is = 50mA and 25°C (Room Temperature)																																																																																																												
11	NA	Add Backside Compression spec.																																																																																																												



Product Specification

M170ETN01.1

AU OPTRONICS CORPORATION

1 Handling Precautions

- 1) Since front polarizer is easily damaged, pay attention not to scratch it.
- 2) Be sure to turn off power supply when inserting or disconnecting from input connector.
- 3) Wipe off water drop immediately. Long contact with water may cause discoloration or spots.
- 4) When the panel surface is soiled, wipe it with absorbent cotton or other soft cloth.
- 5) Since the panel is made of glass, it may break or crack if dropped or bumped on hard surface.
- 6) Since CMOS LSI is used in this module, take care of static electricity and insure human earth when handling.
- 7) Do not open or modify the Module Assembly.
- 8) Do not press the reflector sheet at the back of the module to any directions.
- 9) In case a TFT-LCD Module has to be put back into the packing container slot after once it was taken out from the container, do not press the center of the LED lightbar edge. Otherwise the TFT-LCD Module may be damaged.
- 10) Insert or pull out the interface connector, be sure not to rotate nor tilt it of the TFT-LCD Module.
- 11) Do not twist nor bend the TFT -LCD Module even momentary. It should be taken into consideration that no bending/twisting forces are applied to the TFT-LCD Module from outside. Otherwise the TFT-LCD Module may be damaged.
- 12) Please avoid touching COF position while you are doing mechanical design.
- 13) When storing modules as spares for a long time, the following precaution is necessary:
Store them in a dark place. Do not expose the module to sunlight or fluorescent light. Keep the temperature between 5□ and 35□ at normal humidity.



Product Specification

M170ETN01.1

AU OPTRONICS CORPORATION

2 General Description

This specification applies to the 17 inch wide Color a-Si TFT-LCD Module M170ETN01.1. The display supports the SXGA+ (1280(H) x 1024(V)) screen format and 16.7M colors (8bits RGB data input). The input interface is Dual channel LVDS and this module doesn't contain an driver board for backlight.

2.1 Display Characteristics

The following items are characteristics summary on the table under 25℃ condition:

ITEMS	Unit	SPECIFICATIONS
Screen Diagonal	[mm]	432 (17.0")
Active Area	[mm]	337.92(H) × 270.34(V)
Pixels H x V	-	1280 × 3(RGB) × 1024
Pixel Pitch	[mm]	0.264(per one triad) × 0.264
Pixel Arrangement	-	R.G.B. Vertical Stripe
Display Mode	-	Normally White
White Luminance (Center)	[cd/m ²]	250 (Typ.)
Contrast Ratio	-	1000 : 1 (Typ.)
Response Time	[msec]	5 (Typ., on/off)
Power Consumption (LCD Module + Backligh unit)	[Watt]	8.4W (Typ.) LCD module : PDD (Typ.)=3W @ Black pattern, Fv=60Hz Backlight unit : PBLU (Typ.) =5.4W @Is=50mA
Weight	[Grams]	1270 (Typ.)
Outline Dimension	[mm]	358.5(H) x 296.5(V) x 10.3(D) (Typ.)
Electrical Interface	-	Dual Channel LVDS(8bits RGB data input)
Support Color	-	16.7M colors
Surface Treatment	-	Anti-glare type, Hardness 3H
Temperature Range		
Operating	[°C]	0 to +50
Storage (Shipping)	[°C]	-20 to +60
RoHS Compliance	-	RoHS Compliance
TCO Compliance	-	TCO7.0 Compliance



Product Specification

M170ETN01.1

AU OPTRONICS CORPORATION

2.2 Absolute Maximum Rating of Environment

Permanent damage may occur if exceeding the following maximum rating.

Symbol	Description	Min.	Max.	Unit	Remark
TOP	Operating Temperature	0	+50	[°C]	Note 2-1
TGS	Glass surface temperature (operation)	0	+65	[°C]	Note 2-1 Function judged only
HOP	Operation Humidity	5	90	[%RH]	Note 2-1
TST	Storage Temperature	-20	+60	[°C]	
HST	Storage Humidity	5	90	[%RH]	

Note 2-1: Temperature and relative humidity range are shown as the below figure.

1. 90% RH Max ($T_a \leq 39^\circ\text{C}$)
2. Max wet-bulb temperature at 39°C or less. ($T_a \leq 39^\circ\text{C}$)
3. No condensation

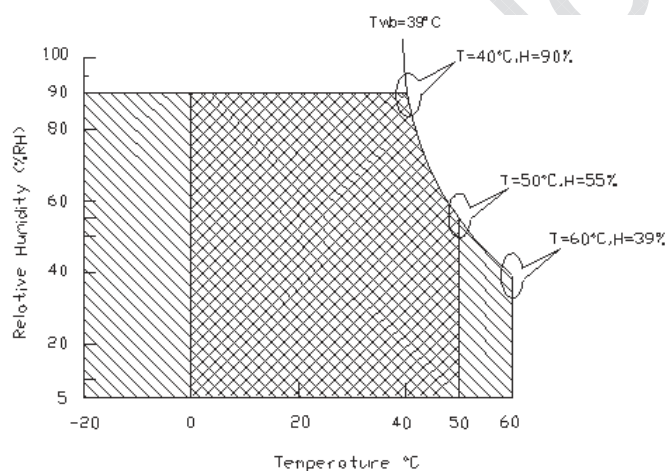

Operating Range



Storage Range

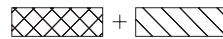



Product Specification

M170ETN01.1

AU OPTRONICS CORPORATION

2.3 Optical Characteristics

The optical characteristics are measured on the following test condition.

Test Condition:

1. Equipment setup: Please refer to **Note 2-2**.
2. Panel Lighting time: 30 minutes
3. VDD=5.0V, Fv=60Hz, Is=50mA, Ta=25°C

Symbol	Description		Min.	Typ.	Max.	Unit	Remark
L _w	White Luminance (Center of screen)		200	250	-	[cd/m ²]	Note 2-2 By SR-3
L _{uni}	Luminance Uniformity (9 points)		75	80	-	[%]	Note 2-3 By SR-3
CR	Contrast Ratio (Center of screen)		600	1000	-	-	Note 2-4 By SR-3
θ _R	Horizontal Viewing Angle (CR=10)	Right	75	85	-	[degree]	Note 2-5 By SR-3
θ _L		Left	75	85	-		
Φ _H	Vertical Viewing Angle (CR=10)	Up	70	80	-		
Φ _L		Down	70	80	-		
θ _R	Horizontal Viewing Angle (CR=5)	Right	75	88	-		
θ _L		Left	75	88	-		
Φ _H	Vertical Viewing Angle (CR=5)	Up	70	85	-		
Φ _L		Down	70	85	-		
T _R	Response Time	Rising Time	-	3.8	5.5	[msec]	Note 2-6 By TRD-100
T _F		Falling Time	-	1.2	2.5		
-		Rising + Falling	-	5	8		
R _x	Color Coordinates (CIE 1931)	Red x	0.617	0.647	0.677	-	By SR-3
R _y		Red y	0.305	0.335	0.365		
G _x		Green x	0.290	0.320	0.350		
G _y		Green y	0.591	0.621	0.651		
B _x		Blue x	0.124	0.154	0.184		
B _y		Blue y	0.031	0.061	0.091		
W _x		White x	0.283	0.313	0.343		
W _y		White y	0.299	0.329	0.359		
CT	Crosstalk		-	-	1.5	[%]	Note 2-7 By SR-3
F _{dB}	Flicker (Center of screen)		-	-	-20	[dB]	Note 2-8 By SR-3



Product Specification

M170ETN01.1

AU OPTRONICS CORPORATION

Note 2-2: Equipment setup :

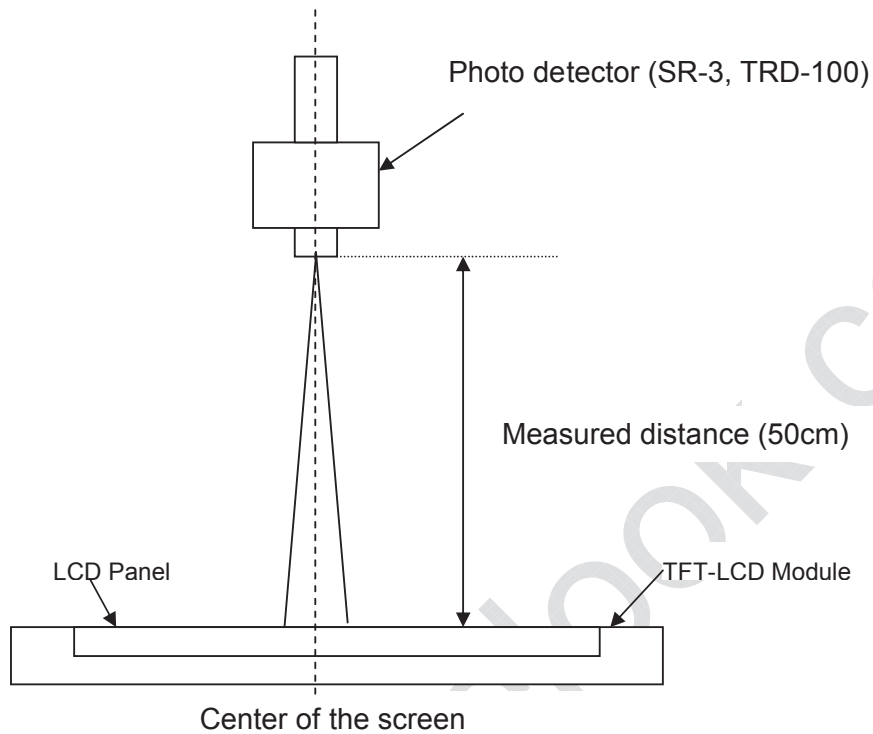

Note 2-3: Luminance Uniformity Measurement

Definition:

$$\text{Luminance Uniformity} = \frac{\text{Minimum Luminance of 9 Points (P1 ~ P9)}}{\text{Maximum Luminance of 9 Points (P1 ~ P9)}}$$

a. Test pattern: White Pattern

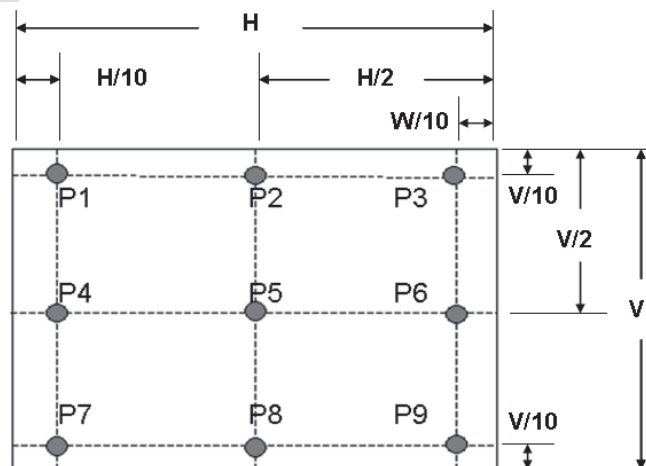



Product Specification

M170ETN01.1

AU OPTRONICS CORPORATION

Note 2-4: Contrast Ratio Measurement

Definition:

$$\text{Contrast Ratio} = \frac{\text{Luminance of White pattern}}{\text{Luminance of Black pattern}}$$

- a. Measured position: Center of screen (P5) & perpendicular to the screen ($\theta = \phi = 0^\circ$)

Note 2-5: Viewing angle measurement

Definition: The angle at which the contrast ratio is greater than 10 & 5 .

- a. Horizontal view angle: Divide to left & right (θ_L & θ_R)
Vertical view angle: Divide to up & down (ϕ_H & ϕ_L)

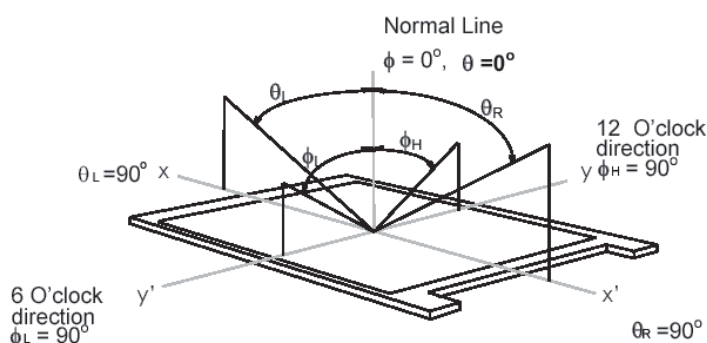

Note 2-6: Response time measurement

The output signals of photo detector are measured when the input signals are changed from "Black" to "White" (rising time, T_R), and from "White" to "Black" (falling time, T_F), respectively. The response time is interval between the 10% and 90% of optical response. (*Black & White color definition: Please refer section 3.4.3*)

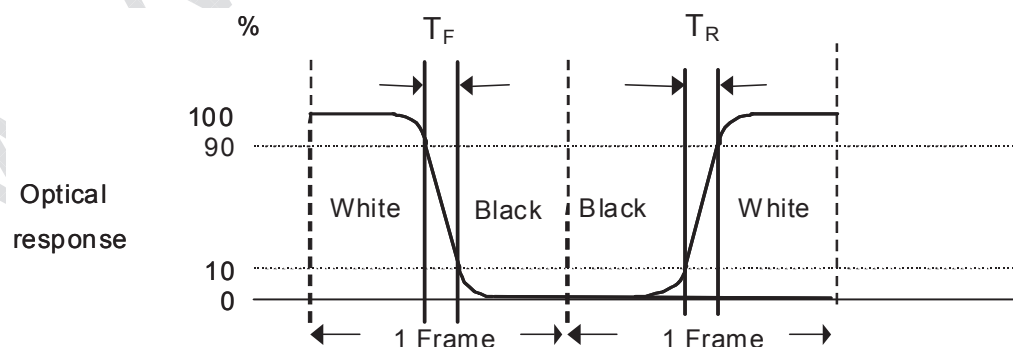



Product Specification

M170ETN01.1

AU OPTRONICS CORPORATION

Note 2-7: Crosstalk measurement

Definition:

$$CT = \text{Max. } (CT_H, CT_V);$$

Where

a. Maximum Horizontal Crosstalk :

$$CT_H = \text{Max. } (|Y_{BL} - Y_{AL}| / Y_{AL} \times 100\%, |Y_{BR} - Y_{AR}| / Y_{AR} \times 100\%);$$

Maximum Vertical Crosstalk:

$$CT_V = \text{Max. } (|Y_{BU} - Y_{AU}| / Y_{AU} \times 100\%, |Y_{BD} - Y_{AD}| / Y_{AD} \times 100\%);$$

b. $Y_{AU}, Y_{AD}, Y_{AL}, Y_{AR}$ = Luminance of measured location without Black pattern

$Y_{BU}, Y_{BD}, Y_{BL}, Y_{BR}$ = Luminance of measured location with Black pattern

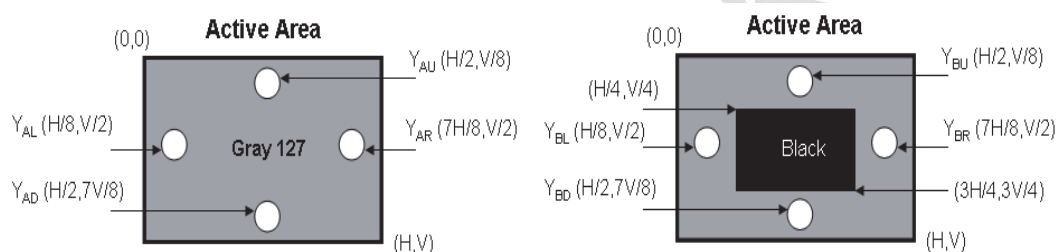

Note 2-8: Flicker measurement

a. Test pattern: It is listed as following.

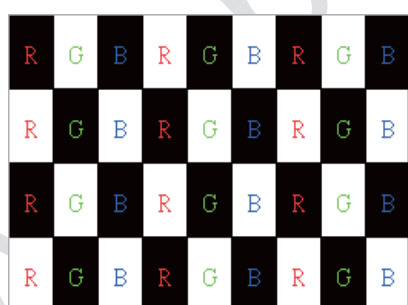

R: Red, G: Green, B:Blue



Gray level = L0



Gray level = L127

b. Measured position: Center of screen (P5) & perpendicular to the screen ($\theta = \Phi = 0^\circ$)



Product Specification

M170ETN01.1

AU OPTRONICS CORPORATION

2.4 Mechanical Characteristics

Symbol	Description	Min.	Max.	Unit	Remark
P _{bc}	Backside Compression	2.5	-	[Kgf]	Note 2-9

Note 2-9: Test Method:

The point is at a distance from right-downside 25mm x 25mm defined as the Start Point of Measure Points, and the point is at a distance 25mm from left-side & around 10mm from PCB defined as the End Point.

Align 50mm x 50mm block from Start Point on the Bezel Back, and the corners of each block are Measure Points.

If the distance from the last block to each side of the End Point \square 25mm, add other blocks to make sure that most area of Bezel Back can be measured.

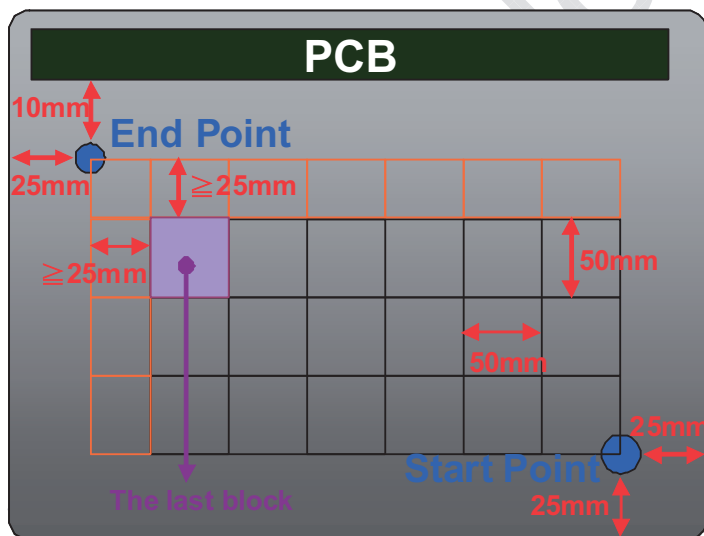



Product Specification

M170ETN01.1

AU OPTRONICS CORPORATION

3 TFT-LCD Module

3.1 Block Diagram

The following shows the block diagram of the 17 inch Color TFT-LCD Module.

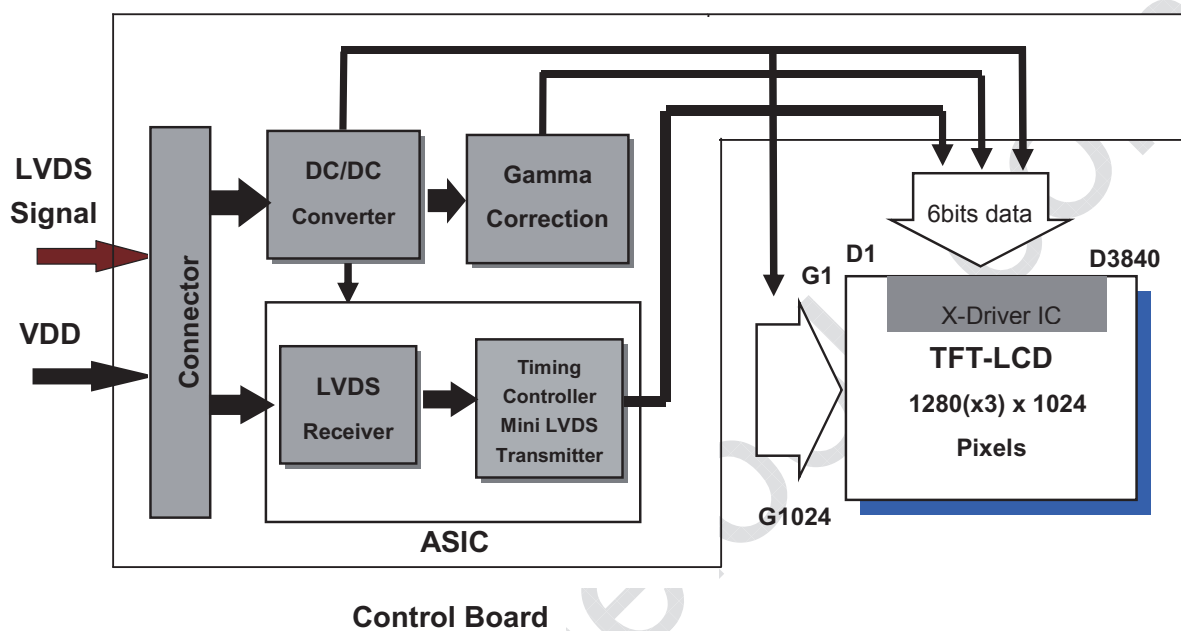



Product Specification

M170ETN01.1

AU OPTRONICS CORPORATION

3.2 Interface Connection

3.2.1 Connector Type

TFT-LCD Connector	Manufacturer	P-TWO	STM
	Part Number	AL230F-A0G1D-P	MSCKT2407P30HB
Mating Connector	Manufacturer	JAE	
	Part Number	FI-X30HL (Locked Type)	

3.2.2 Connector Pin Assignment

PIN #	Symbol	Description	Remark
1	RxO0-	Negative LVDS differential data input (Odd data)	
2	RxO0+	Positive LVDS differential data input (Odd data)	
3	RxO1-	Negative LVDS differential data input (Odd data)	
4	RxO1+	Positive LVDS differential data input (Odd data)	
5	RxO2-	Negative LVDS differential data input (Odd data)	
6	RxO2+	Positive LVDS differential data input (Odd data)	
7	GND	Ground	
8	RxOCLK-	Negative LVDS differential clock input (Odd clock)	
9	RxOCLK+	Positive LVDS differential clock input (Odd clock)	
10	RxO3-	Negative LVDS differential data input (Odd data)	
11	RxO3+	Positive LVDS differential data input (Odd data)	
12	RxE0-	Negative LVDS differential data input (Even data)	
13	RxE0+	Positive LVDS differential data input (Even data)	
14	GND	Ground	
15	RxE1-	Negative LVDS differential data input (Even data)	
16	RxE1+	Positive LVDS differential data input (Even data)	
17	GND	Ground	
18	RxE2-	Negative LVDS differential data input (Even data)	
19	RxE2+	Positive LVDS differential data input (Even data)	
20	RxECLK-	Negative LVDS differential clock input (Even clock)	
21	RxECLK+	Positive LVDS differential clock input (Even clock)	
22	RxE3-	Negative LVDS differential data input (Even data)	
23	RxE3+	Positive LVDS differential data input (Even data)	
24	GND	Ground	
25	NC	No connection (for AUO test only. Do not connect)	
26	NC	No connection (for AUO test only. Do not connect)	



Product Specification

M170ETN01.1

AU OPTRONICS CORPORATION

27	NC	No connection (for AUO test only. Do not connect)	
28	VDD	Power Supply Input Voltage	
29	VDD	Power Supply Input Voltage	
30	VDD	Power Supply Input Voltage	

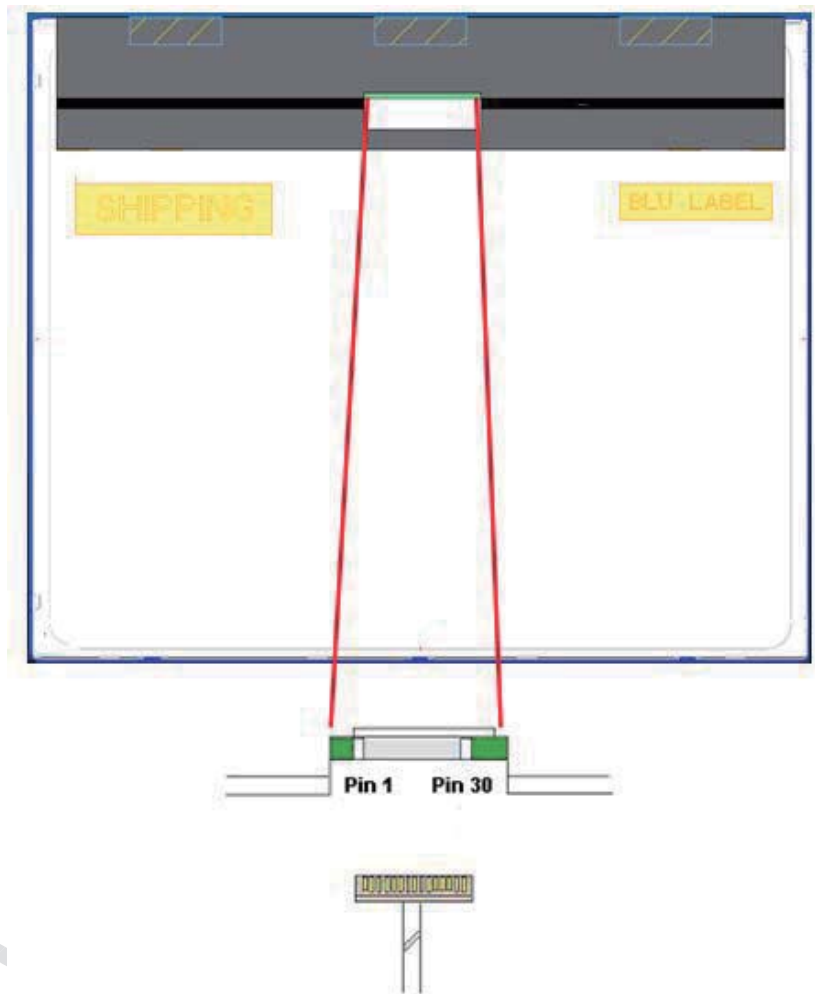



Product Specification

M170ETN01.1

AU OPTRONICS CORPORATION

3.3 Electrical Characteristics

3.3.1 Absolute Maximum Rating

Permanent damage may occur if exceeding the following maximum rating.

Symbol	Description	Min	Max	Unit	Remark
VDD	Power Supply Input Voltage	GND-0.3	6.0	[Volt]	Ta=25□

3.3.2 Recommended Operating Condition

Symbol	Description	Min	Typ	Max	Unit	Remark
VDD	Power supply Input voltage	4.5	5.0	5.5	[Volt]	
IDD	Power supply Input Current (RMS)	-	0.6	0.72	[A]	VDD= 5.0V, Black Pattern, Fv=60Hz
		-	0.72	0.87	[A]	VDD= 5.0V, Black Pattern, Fv=75Hz
PDD	VDD Power Consumption	-	3	3.6	[Watt]	VDD= 5.0V, Black Pattern, Fv=60Hz
		-	3.6	4.32	[Watt]	VDD= 5.0V, Black Pattern, Fv=75Hz
IRush	Inrush Current	-	-	3.0	[A]	Note 3-1
VDDrp	Allowable VDD Ripple Voltage	-	-	500	[mV]	VDD= 5.0V, Black Pattern, Fv=75Hz

Note 3-1: Inrush Current measurement:

Test circuit:

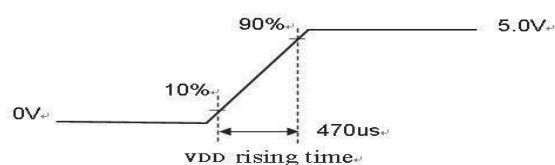
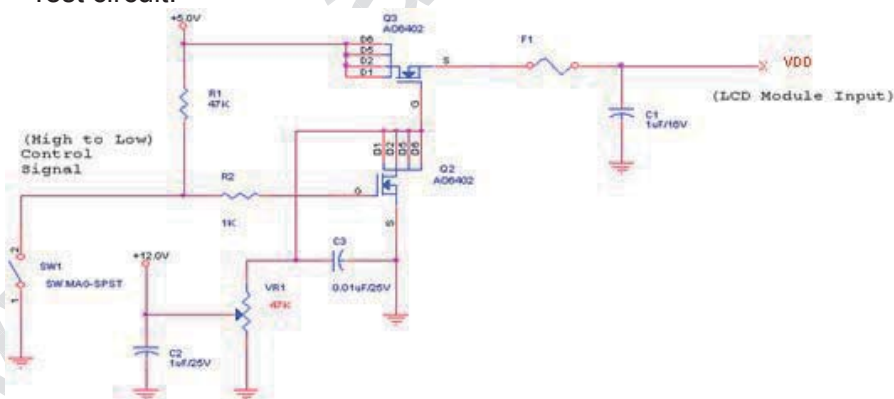

The duration of VDD rising time: 470us.



Product Specification

M170ETN01.1

AU OPTRONICS CORPORATION

3.4 Signal Characteristics

3.4.1 LCD Pixel Format

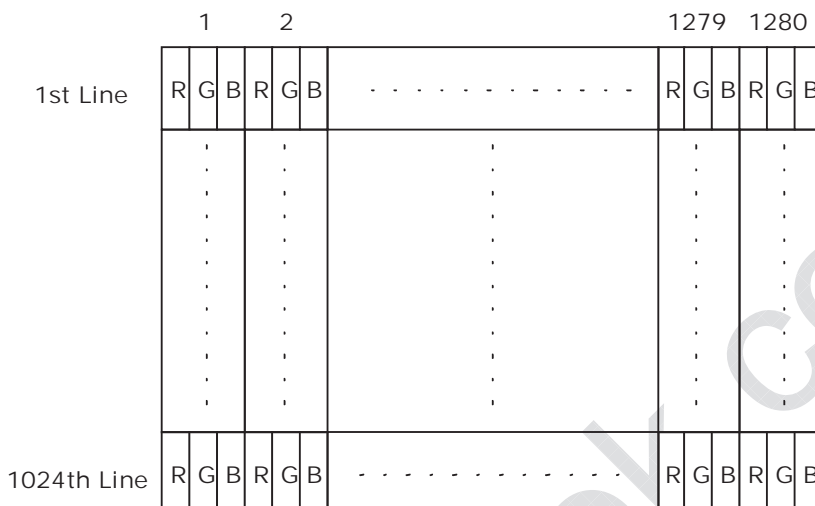

3.4.2 LVDS Data Format

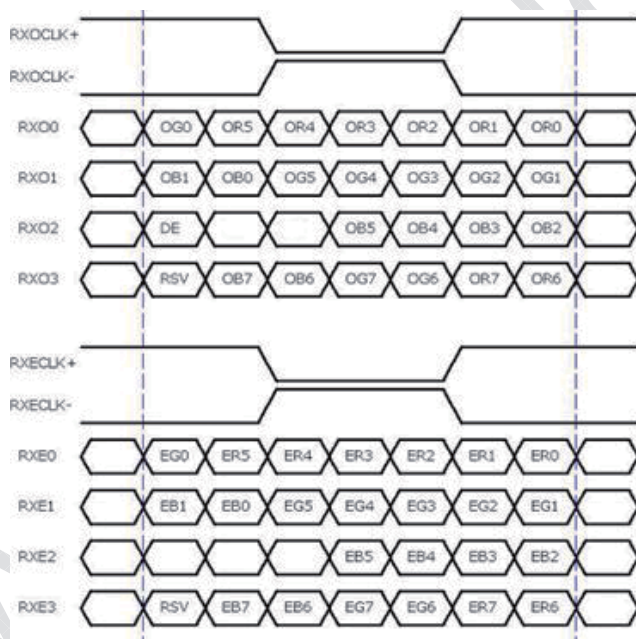

8 Bit Color Bit Order			
MSB	R7	G7	B7
	R6	G6	B6
	R5	G5	B5
	R4	G4	B4
	R3	G3	B3
	R2	G2	B2
	R1	G1	B1
LSB	R0	G0	B0

Note 3-2:

- a. O = "Odd Pixel Data" E = "Even Pixel Data"
- b. Refer to 3.4.1 LCD pixel format, the 1st data is 1 (Odd Pixel Data), the 2nd data is 2 (Even Pixel Data) and the last data is 1280 (Even Pixel Data).



Product Specification

M170ETN01.1

AU OPTRONICS CORPORATION

3.4.3 Color versus Input Data

The following table is for color versus input data (8bit). The higher the gray level, the brighter the color.

Color	Gray Level	Color Input Data																				Remark				
		RED data (MSB:R7, LSB:R0)								GREEN data (MSB:G7, LSB:G0)								BLUE data (MSB:B7, LSB:B0)								
		R7	R6	R5	R4	R3	R2	R1	R0	G7	G6	G5	G4	G3	G2	G1	G0	B7	B6	B5	B4		B3	B2	B1	B0
Black	-	0	0	0	0	0	0	0	0	0	0	0	0	0	0	0	0	0	0	0	0	0	0	0	0	
White	-	1	1	1	1	1	1	1	1	1	1	1	1	1	1	1	1	1	1	1	1	1	1	1	1	
Gray 127	-	0	1	1	1	1	1	1	1	0	1	1	1	1	1	1	1	0	1	1	1	1	1	1	1	
Red	L0	0	0	0	0	0	0	0	0	0	0	0	0	0	0	0	0	0	0	0	0	0	0	0	0	Black
	:	:	:	:	:	:	:	:	:	:	:	:	:	:	:	:	:	:	:	:	:	:	:	:	:	
	L255	1	1	1	1	1	1	1	1	0	0	0	0	0	0	0	0	0	0	0	0	0	0	0	0	
Green	L0	0	0	0	0	0	0	0	0	0	0	0	0	0	0	0	0	0	0	0	0	0	0	0	0	Black
	:	:	:	:	:	:	:	:	:	:	:	:	:	:	:	:	:	:	:	:	:	:	:	:	:	
	L255	0	0	0	0	0	0	0	0	1	1	1	1	1	1	1	1	0	0	0	0	0	0	0	0	
Blue	L0	0	0	0	0	0	0	0	0	0	0	0	0	0	0	0	0	0	0	0	0	0	0	0	0	Black
	:	:	:	:	:	:	:	:	:	:	:	:	:	:	:	:	:	:	:	:	:	:	:	:	:	
	L255	0	0	0	0	0	0	0	0	0	0	0	0	0	0	0	0	1	1	1	1	1	1	1	1	



Product Specification

M170ETN01.1

AU OPTRONICS CORPORATION

3.4.4 LVDS Specification

a. DC Characteristics:

Symbol	Description	Min	Typ	Max	Units	Condition
V_{TH}	LVDS Differential Input High Threshold	-	-	+100	[mV]	$V_{CM} = 1.2V$
V_{TL}	LVDS Differential Input Low Threshold	-100	-	-	[mV]	$V_{CM} = 1.2V$
$ V_{ID} $	LVDS Differential Input Voltage	100	-	600	[mV]	
V_{CM}	LVDS Common Mode Voltage	+1.0	+1.2	+1.5	[V]	$V_{TH} - V_{TL} = 200mV$

LVDS Signal Waveform:

Use RxOCLK- & RxOCLK+ as example.

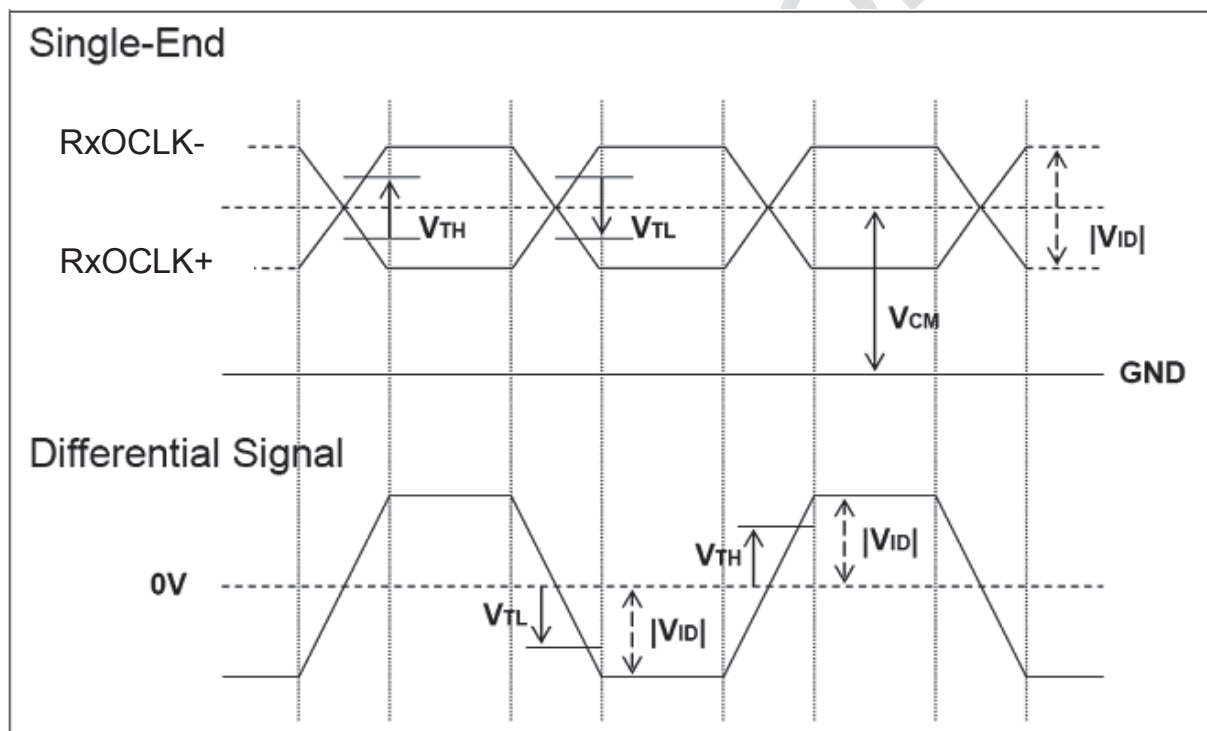



Product Specification

M170ETN01.1

AU OPTRONICS CORPORATION

b. AC Characteristics:

Symbol	Description	Min	Max	Unit	Remark
F_{DEV}	Maximum deviation of input clock frequency during Spread Spectrum	-	± 3	%	
F_{MOD}	Maximum modulation frequency of input clock during Spread Spectrum	-	200	KHz	

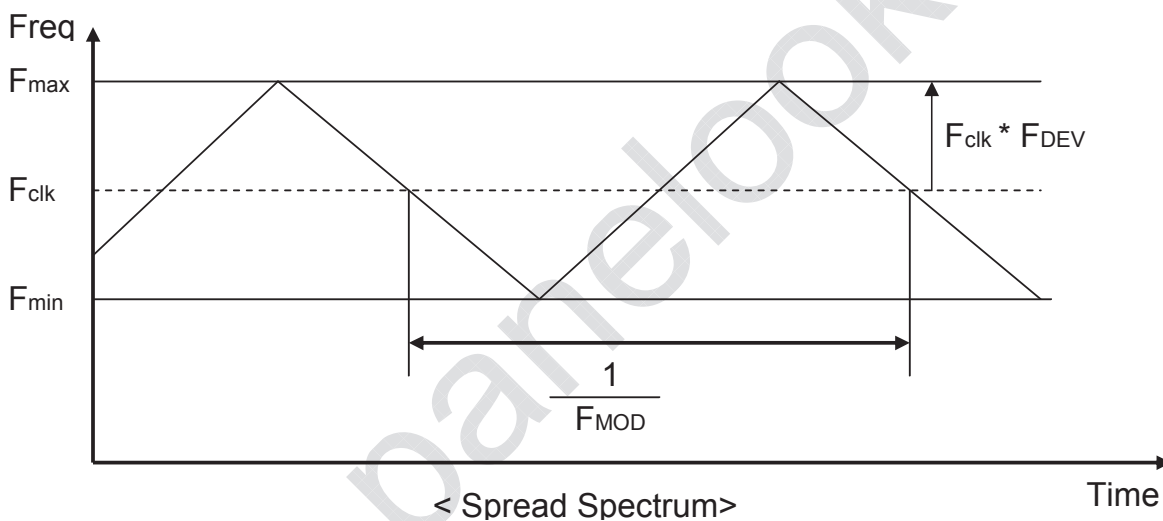

Fclk: LVDS Clock Frequency



Product Specification

M170ETN01.1

AU OPTRONICS CORPORATION

3.4.5 Input Timing Specification

It only support DE mode, and the input timing are shown as the following table.

Symbol	Description		Min.	Typ.	Max.	Unit	Remark
Tv	Vertical Section	Period	1036	1066	1873	Th	
Tdisp (v)		Active	1024	1024	1024	Th	
Tblk (v)		Blanking	12	42	849	Th	
Fv		Frequency	50	60	76	Hz	
Th	Horizontal Section	Period	730	844	1320	Tclk	
Tdisp (h)		Active	640	640	640	Tclk	
Tblk (h)		Blanking	90	204	680	Tclk	
Fh		Frequency	51.8	64	93.7	KHz	Note 3-3
Tclk	LVDS Clock	Period	14.6	18.5	26	ns	1/Fclk
Fclk		Frequency	37.8	54	68.4	MHz	Note 3-4

Note 3-3: The equation is listed as following. Please don't exceed the above recommended value.

$$Fh (\text{Min.}) = Fclk (\text{Min.}) / Th (\text{Min.});$$

$$Fh (\text{Typ.}) = Fclk (\text{Typ.}) / Th (\text{Typ.});$$

$$Fh (\text{Max.}) = Fclk (\text{Max.}) / Th (\text{Min.});$$

Note 3-4: The equation is listed as following. Please don't exceed the above recommended value.

$$Fclk (\text{Min.}) = Fv (\text{Min.}) \times Th (\text{Min.}) \times Tv (\text{Min.});$$

$$Fclk (\text{Typ.}) = Fv (\text{Typ.}) \times Th (\text{Typ.}) \times Tv (\text{Typ.});$$

$$Fclk (\text{Max.}) = Fv (\text{Max.}) \times Th (\text{Typ.}) \times Tv (\text{Typ.});$$



Product Specification

M170ETN01.1

AU OPTRONICS CORPORATION

3.4.6 Input Timing Diagram

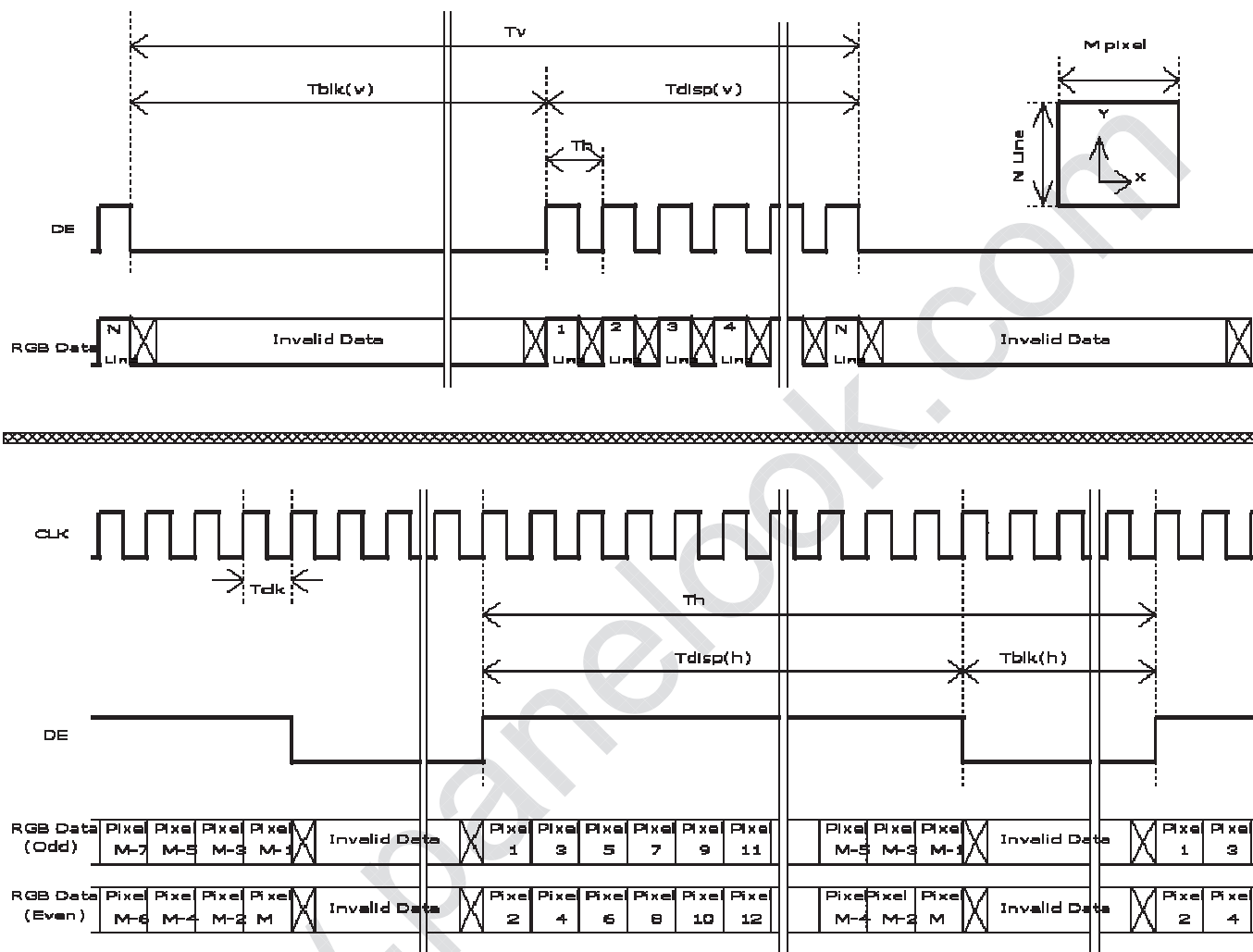



Product Specification

M170ETN01.1

AU OPTRONICS CORPORATION

3.5 Power ON/OFF Sequence

VDD power, LVDS signal and backlight on/off sequence are as following. LVDS signals from any system shall be Hi-Z state when VDD is off.

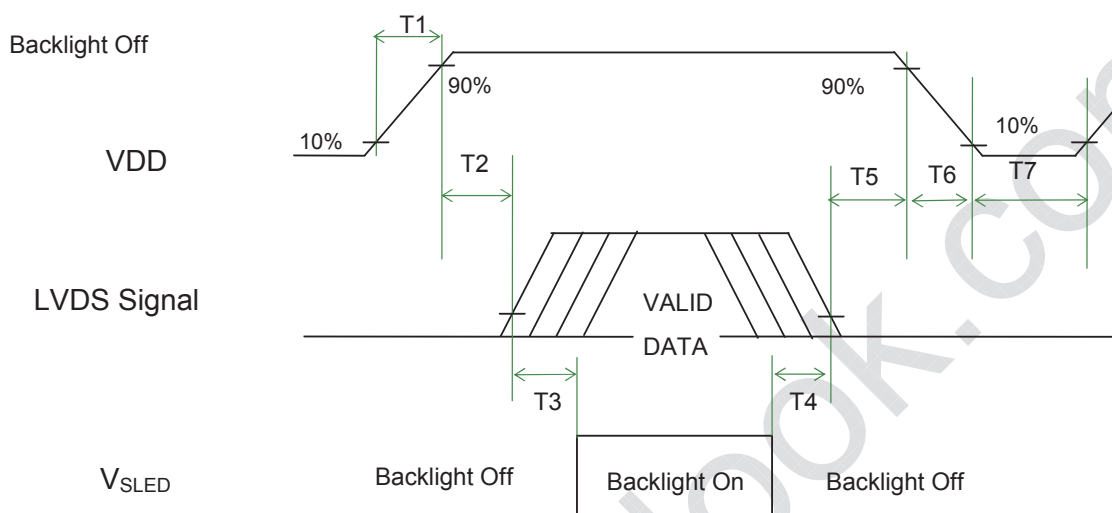

Power Sequence Timing

Symbol	Value			Unit	Remark
	Min.	Typ.	Max.		
T1	0.5	-	10	[ms]	
T2	0	-	50	[ms]	
T3	500	-	-	[ms]	
T4	100	-	-	[ms]	
T5	0		50	[ms]	Note 3-5 Note 3-6
T6	0	-	150	[ms]	Note 3-6
T7	1000	-	-	[ms]	

Note 3-5 : Recommend setting T5 = 0ms to avoid electronic noise when VDD is off.

Note 3-6 : During T5 and T6 period , please keep the level of input LVDS signals with Hi-Z state.



Product Specification

M170ETN01.1

AU OPTRONICS CORPORATION

4 Backlight Unit

4.1 Block Diagram

The following shows the block diagram of the 17 inch Backlight Unit. And it includes 36 pcs LED in the LED light bar. (4 strings and 9 pcs LED of one string).

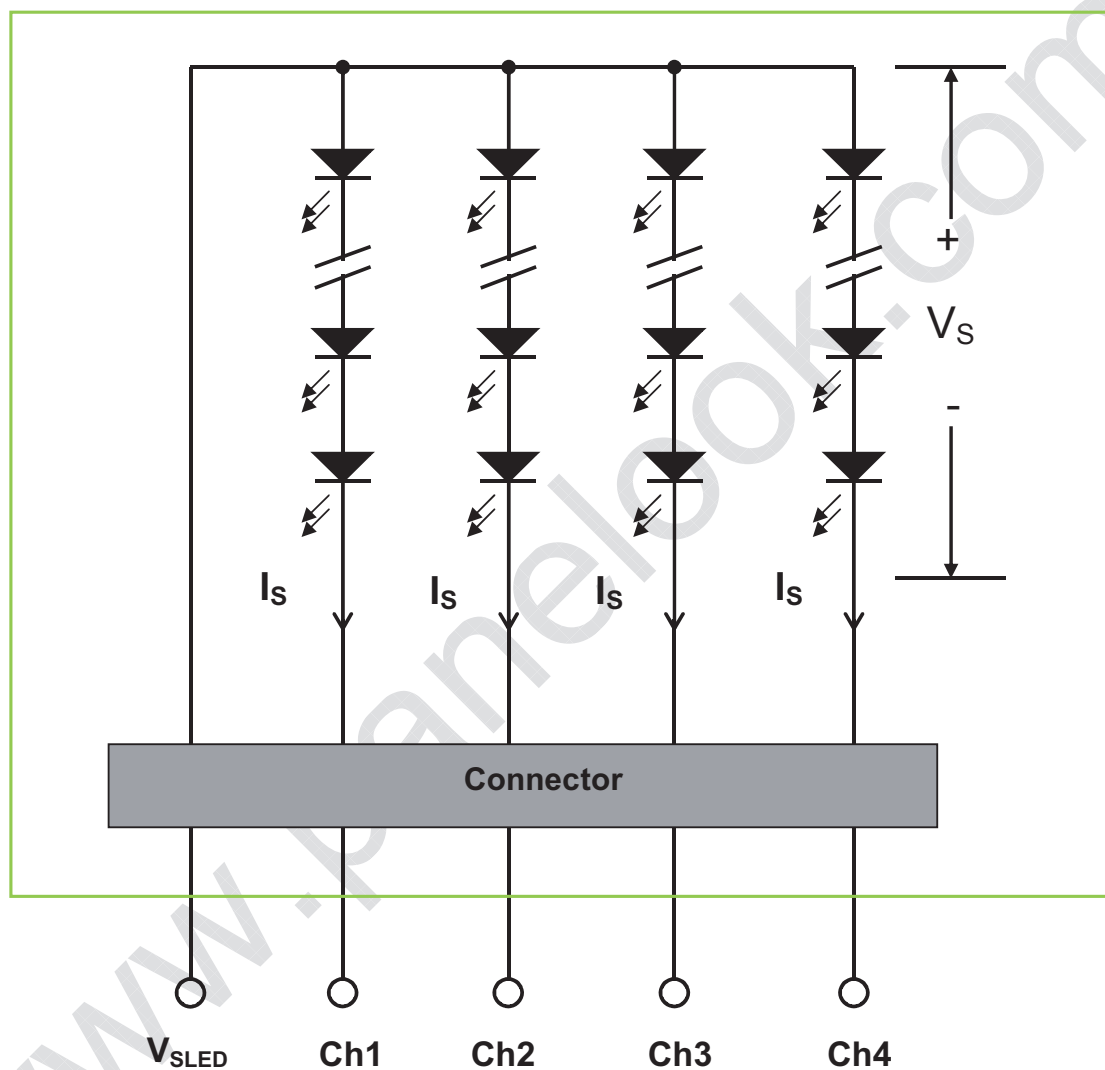



Product Specification

M170ETN01.1

AU OPTRONICS CORPORATION

4.2 Interface Connection

4.2.1 Connector Type

Backlight Connector	Manufacturer	ENTERY
	Part Number	3707K-S06N-21R
Mating Connector	Manufacturer	ENTERY
	Part Number	H112K-P06N-13B (Locking type)

Backlight Connector dimension:

$H \times V \times D = 13.9 \times 3.00 \times 4.25$, $Pitch = 1.0$ (unit = mm)

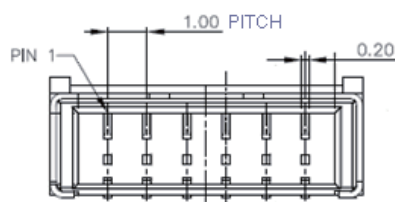
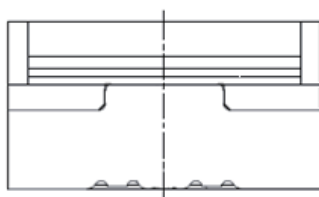



Product Specification

M170ETN01.1

AU OPTRONICS CORPORATION

Mating Connector dimension:

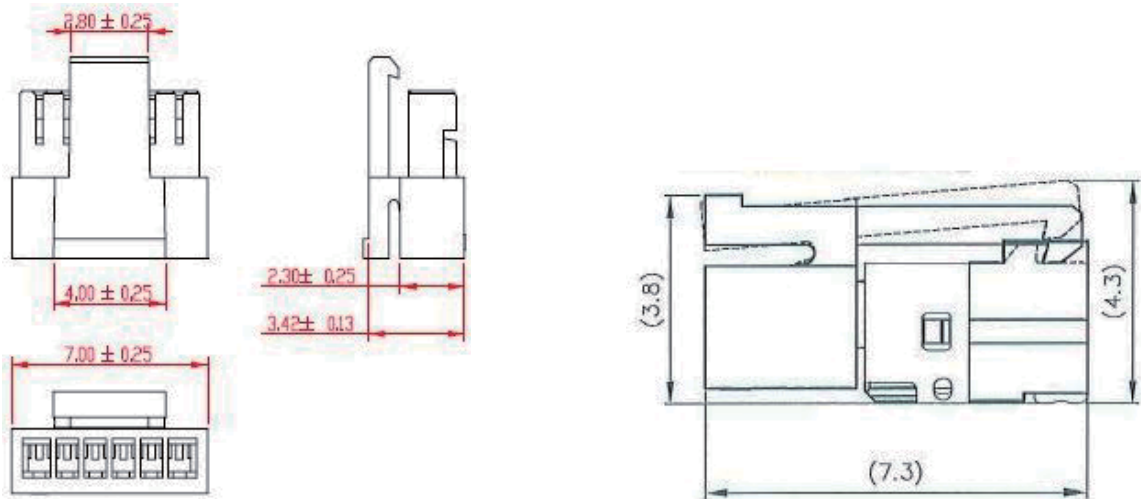



Product Specification

M170ETN01.1

AU OPTRONICS CORPORATION

4.2.2 Connector Pin Assignment

Pin#	Symbol	Description	Remark
1	Ch1	LED Current Feedback Terminal (Channel 1)	
2	Ch2	LED Current Feedback Terminal (Channel 2)	
3	V _{SLED}	LED Power Supply Voltage Input Terminal	
4	V _{SLED}	LED Power Supply Voltage Input Terminal	
5	Ch3	LED Current Feedback Terminal (Channel 3)	
6	Ch4	LED Current Feedback Terminal (Channel 4)	

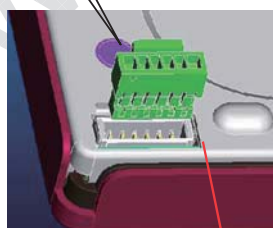
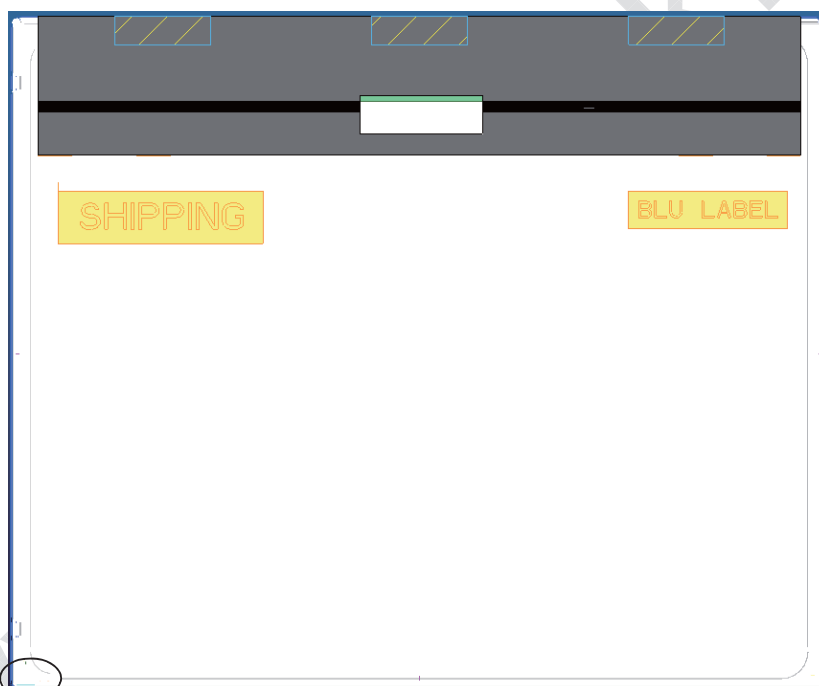

PIN1



Product Specification

M170ETN01.1

AU OPTRONICS CORPORATION

4.3 Electrical Characteristics

4.3.1 Absolute Maximum Rating

Permanent damage may occur if exceeding the following maximum rating.

(Ta=25°C)

Symbol	Description	Min	Max	Unit	Remark
Is	LED String Current	0	120	[mA]	100% duty ratio
			200	[mA]	Duty ratio □ 10% Pulse time=10 ms

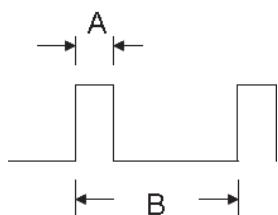

Duty ratio= (A / B) X 100% ; (A: Pulse time, B: Period)

4.3.2 Recommended Operating Condition

(Ta=25°C)

Symbol	Description	Min.	Typ.	Max.	Unit	Remark
Is	LED String Current	-	50	55	[mA]	100% duty ratio of LED chip ; Note 4-6
Vs	LED String Voltage	25.2	27.0	28.8	[Volt]	Is=50mA@100% duty ratio; Note 4-1 Note 4-5 ; Note 4-7
ΔVs	Maximum Vs Voltage Deviation of light bar	-	-	1.8	[Volt]	Is=50mA@100% duty ratio; Note 4-2
PBLU	LED Light Bar Power Consumption	-	5.4	5.8	[Watt]	Note 4-3
LT _{LED}	LED Life Time	30,000	-	-	[Hour]	Note 4-4
OVP	Over Voltage Protection in system board	110% Vs(Max.)			[Volt]	Note 4-5



Product Specification

M170ETN01.1

AU OPTRONICS CORPORATION

Note 4-1: V_s (Typ.) = V_F (Typ.) X LED No. (one string);

- V_F : LED chip forward voltage, V_F (Min.)=2.8V, V_F (Typ.)=3.0V, V_F (Max.)=3.2V
- The same equation to calculate V_s (Min.) & V_s (Max.) for respective V_F (Min.) & V_F (Max.);

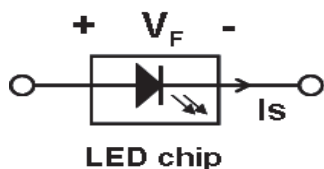

Note 4-2: ΔV_s (Max.) = ΔV_F X LED No. (one string);

- ΔV_F : LED chip forward voltage deviation; (0.2 V , each Bin of LED V_F)

Note 4-3: P_{BLU} (Typ.) = V_s (Typ.) X I_s (Typ.) X 4 ; (4 is total String No. of LED Light bar)

$$P_{BLU} \text{ (Max.)} = V_s \text{ (Max.)} \times I_s \text{ (Typ.)} \times 4 ;$$

Note 4-4: Definition of life time:

- Brightness of LED becomes to 50% of its original value
- Test condition: $I_s = 50\text{mA}$ and 25°C (Room Temperature)

Note 4-5: Recommendation for LED driver power design:

Due to there are electrical property deviation in LED & monitor set system component after long time operation. AUO strongly recommend the design value of LED driver board OVP (over voltage protection) should be 10% higher than max. value of LED string voltage (V_s) at least.

Note 4-6: AUO strongly recommend "Analog Dimming" method for backlight brightness control for Wavy Noise Free. Otherwise, recommend that Dimming Control Signal (PWM Signal) should be synchronized with Frame Frequency.

Note 4-7: Ensure that the LED light bar is not subjected either forward or reverse voltage while monitor set is on standby mode or not in use.



Product Specification

M170ETN01.1

AU OPTRONICS CORPORATION

5 Reliability Test

AUO reliability test items are listed as following table. (*Bare Panel only*)

Items	Condition	Remark
Temperature Humidity Bias (THB)	Ta= 50□, 80%RH, 300hours	
High Temperature Operation (HTO)	Ta= 50□, 50%RH, 300hours	
Low Temperature Operation (LTO)	Ta= 0□, 300hours	
High Temperature Storage (HTS)	Ta= 60□, 300hours	
Low Temperature Storage (LTS)	Ta= -20□, 300hours	
Vibration Test (Non-operation)	Acceleration: 1.5 Grms Wave: Random Frequency: 10 - 200 Hz Sweep: 30 Minutes each Axis (X, Y, Z)	
Shock Test (Non-operation)	Acceleration: 50 G Wave: Half-sine Active Time: 20 ms Direction: ±X, ±Y, ±Z (one time for each Axis)	
Drop Test	Height: 61 cm, package test	
Thermal Shock Test (TST)	-20□/30min, 60□/30min, 100 cycles	Note 5-1
On/Off Test	On/10sec, Off/10sec, 30,000 cycles	
ESD (Electro Static Discharge)	Contact Discharge: ± 15KV, 150pF(330Ω) 1sec, 8 points, 25 times/ point.	Note 5-2
	Air Discharge: ± 15KV, 150pF(330Ω) 1sec 8 points, 25 times/ point.	
Altitude Test	Operation:18,000 ft Non-Operation:40,000 ft	

Note 5-1: a. A cycle of rapid temperature change consists of varying the temperature from -20□ to 60□, and back again. Power is not applied during the test.

b. After finish temperature cycling, the unit is placed in normal room ambient for at least 4 hours before power on.

Note 5-2: EN61000-4-2, ESD class B: Certain performance degradation allowed

No data lost

Self-recoverable

No hardware failures.



Product Specification

M170ETN01.1

AU OPTRONICS CORPORATION

6 Shipping Label

The label is on the panel as shown below:

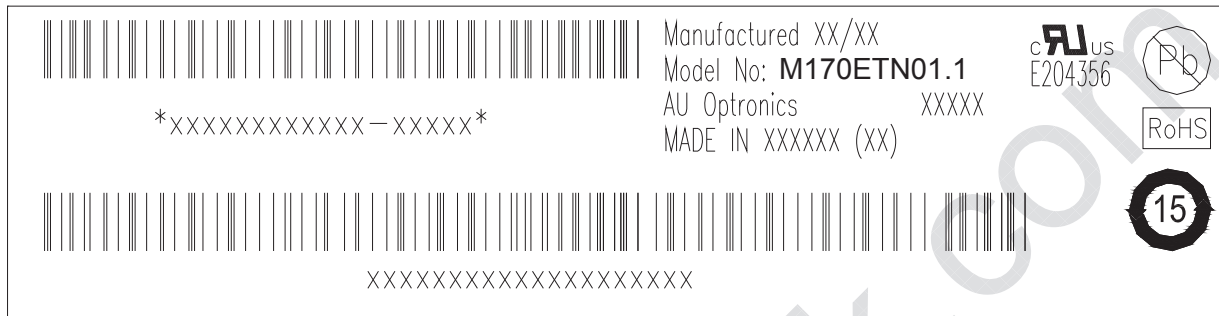

Note 6-1: For Pb Free products, AUO will add  for identification.

Note 6-2: For RoHS compatible products, AUO will add  for identification.

Note 6-3: For China RoHS compatible products, AUO will add  for identification.

Note 6-4: The Green Mark will be presented only when the green documents have been ready by AUO Internal Green Team.

7 Mechanical Characteristics

- Note:
- 1.TORQUE OF (4X) M3 USER HOLE BOSS SHOULD BE WITHIN 4 kg-cm AND RE-SCREW 10 TIMES.
 - 2.LED CONNECTOR IS 3707K-S06A-2(PRE&T) OR EQUIVALENT
 - 3.TOLERANCE UNDEFINED TO BE ±0.5mm.
 - 4.THE DIMENSION EXCLUDES DEFORMATION.
 - 5.MODULE THICKNESS TO BE 10.8MM MAX.
 - 6.LVDS CONNECTOR TO BE JAE FI-KB30SRLAHF16.

Avoid touching COF position when doing mechanical design

Avoid Touching IC Position When Doing Mechanical Design

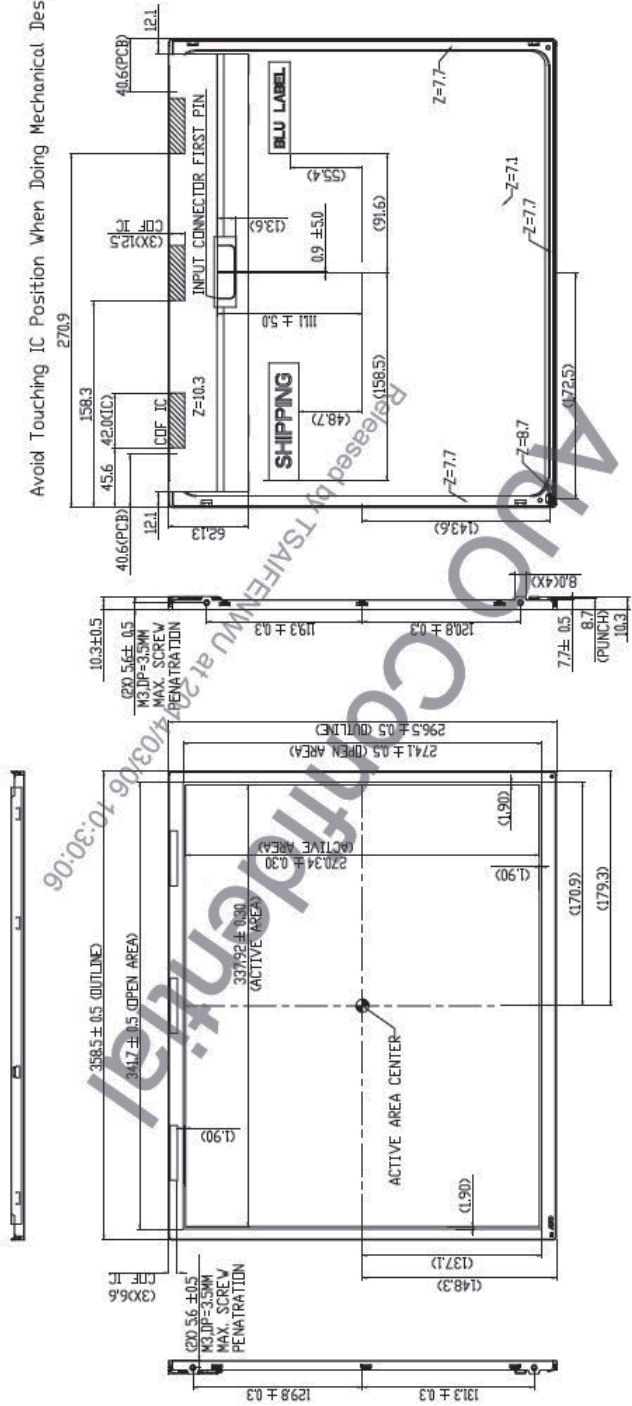

8 Packing Specification

8.1 Packing Flow

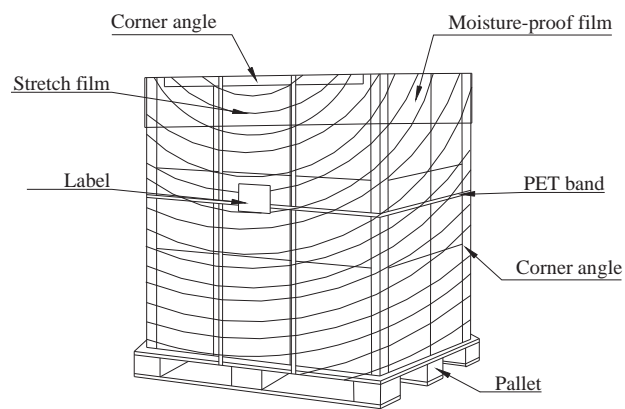
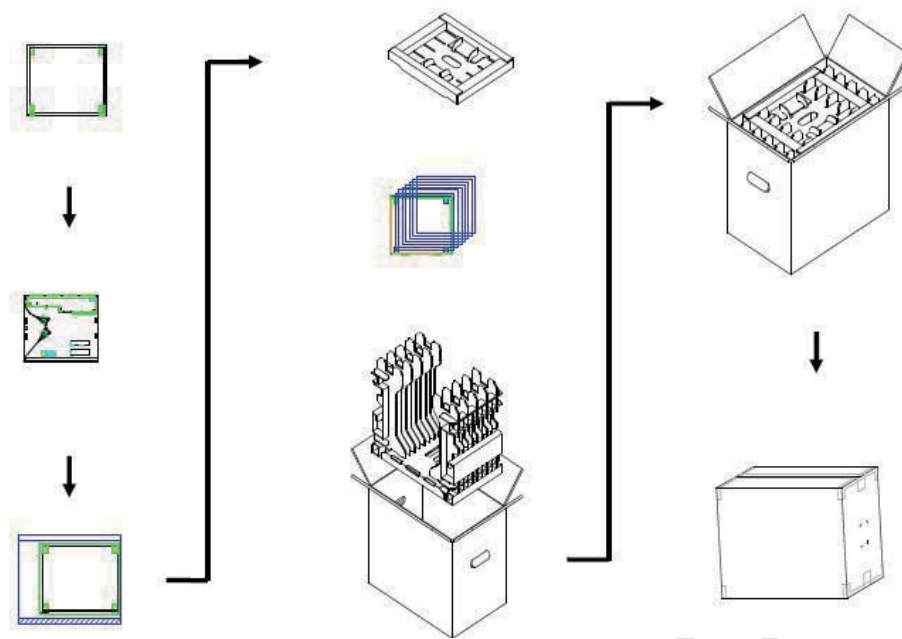

8.2 Pallet and shipment information

Item	Specification			Remark
	Q'ty	Dimension	Weight(kg)	
Panel	1	358.5(H)mm × 296.5(V)mm × 10.3(D)mm	1.273	
Cushion	1	-	0.95	
Box	1	434(L)mm x 278(W)mm x 390(H)mm	0.90	without Panel & cushion
Packing Box	8 pcs/Box	434(L)mm x 278(W)mm x 390(H)mm	12.034	with panel & cushion
Pallet	1	1150(L)mm x 890(W)mm x 132(H)mm	12.00	
Pallet after Packing	18 boxes/pallet	1150(L)mm x 890(W)mm x 131(H)mm	300.816	